



**Teileliste und Näheinrichtungen
Spare Parts List and Sewing Equipment**

975 - 1 - 1

DÜRKOPP ADLER AG

Postfach 17 03 51, D-33703 Bielefeld • Potsdamer Straße 190, D-33719 Bielefeld
Telefon (05 21) 5 56-01 • Telex 932 400-0 da d • Telefax (05 21) 5 56 13 15

Teile-/Part.-No.: 0791 975801

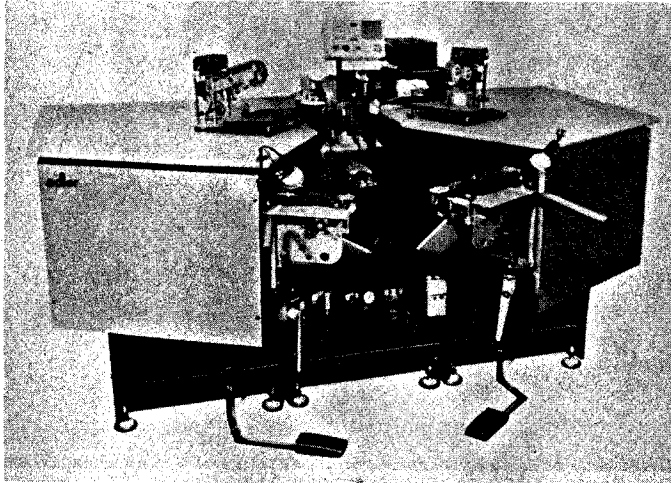

975-1-1/.

Typ:
 Variant:
 Variante

Elektrische Ausführung:
 Electrical equipment:
 Exécution électrique:
 Equipo eléctrico:

- 3x380V, 50 Hz, - 1
- 3x220V, 50 Hz, - 2
- 3x220V, 60 Hz, - 3
- 3x415V, 50 Hz, - 4

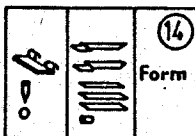
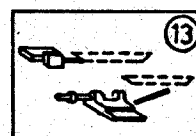
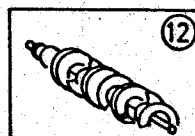
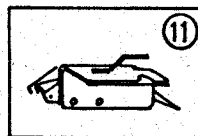
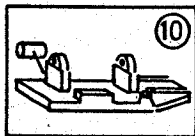
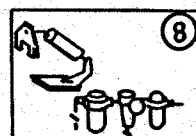
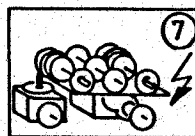
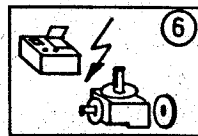
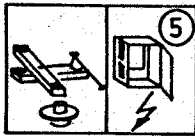
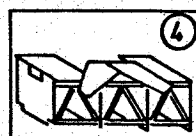
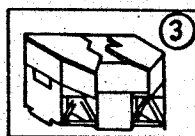
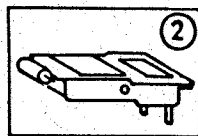
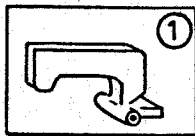

Form

① + ② = 975 43 100 4 ①

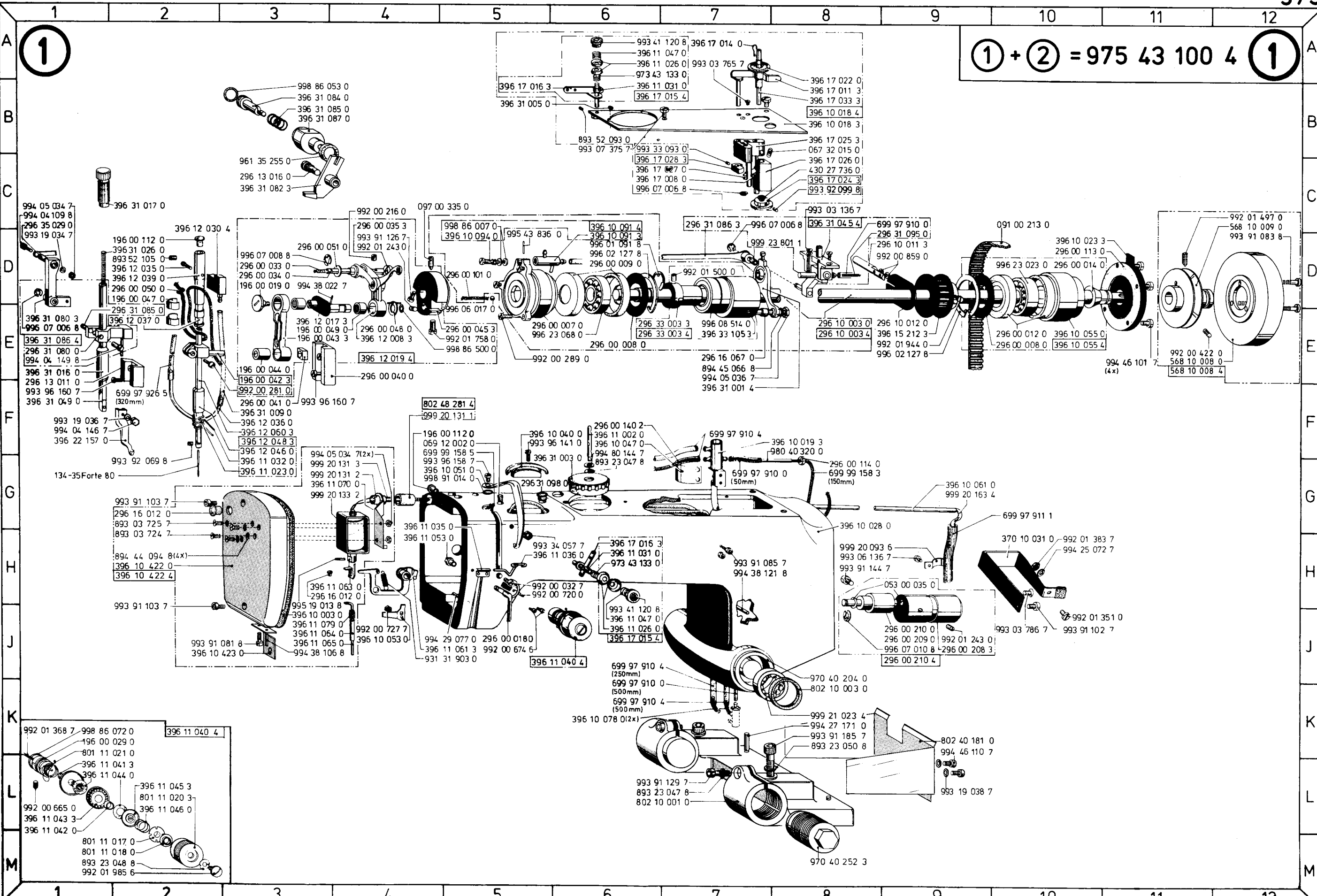

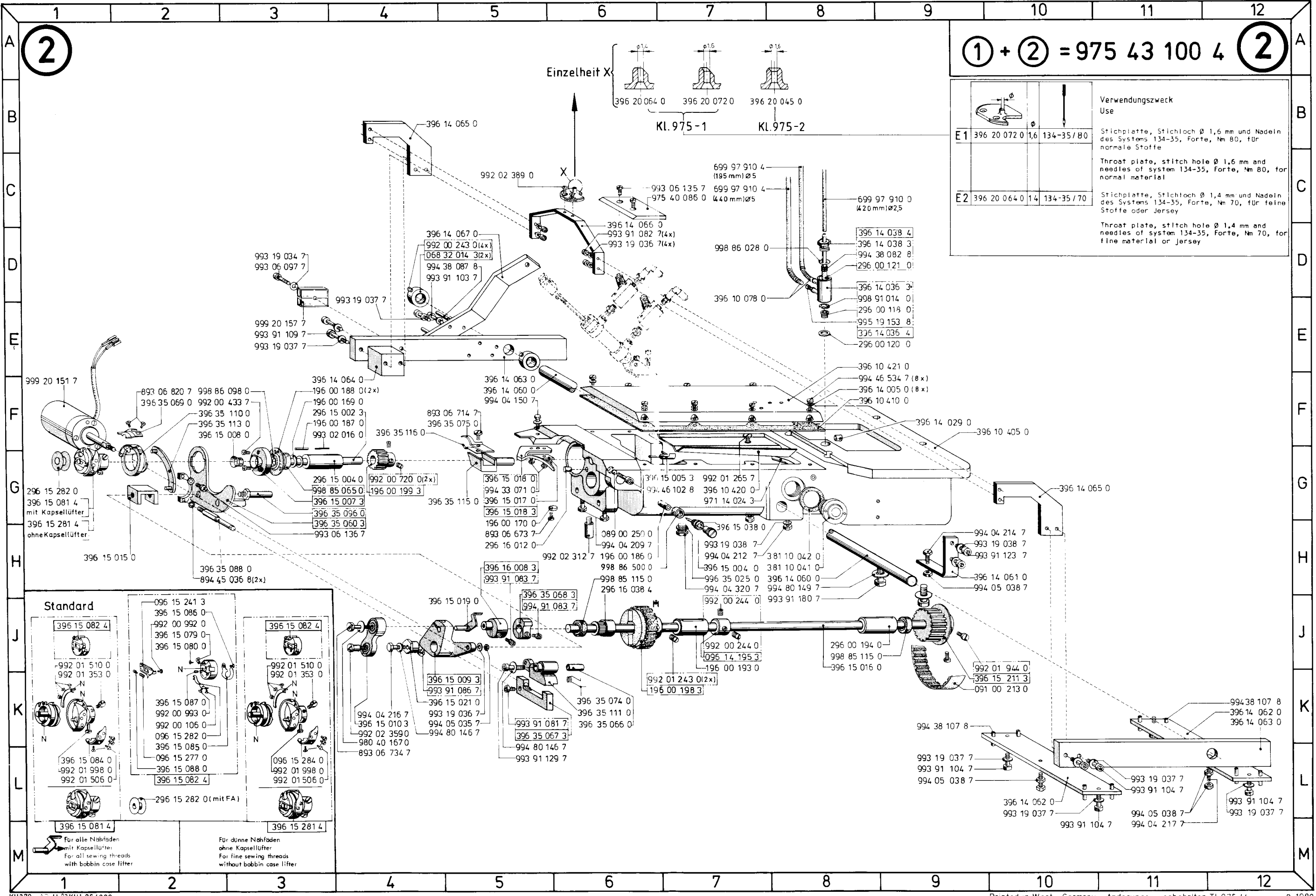

① + ② = 975 43 100 4 ②

	Part No.	Stitch Hole (mm)	Needle System
E1	396 20 072 0	1,6	134-35 / 80
E2	396 20 064 0	1,4	134-35 / 70

Verwendungszweck / Use:
 Stichplatte, Stichloch Ø 1,6 mm und Nadeln des Systems 134-35, Forte, Nm 80, für normale Stoffe
 Throat plate, stitch hole Ø 1,6 mm and needles of system 134-35, Forte, Nm 80, for normal material
 Stichplatte, Stichloch Ø 1,4 mm und Nadeln des Systems 134-35, Forte, Nm 70, für feine Stoffe oder Jersey
 Throat plate, stitch hole Ø 1,4 mm and needles of system 134-35, Forte, Nm 70, for fine material or Jersey

Standard

<p>396 15 082 4</p> <p>992 01 510 0 992 01 353 0</p> <p>396 15 084 0 992 01 998 0 992 01 506 0</p> <p>396 15 081 4</p> <p>Für alle Nähfäden mit Kapsellüfter For all sewing threads with bobbin case lifter</p>	<p>096 15 241 3 396 15 086 0 992 00 992 0 396 15 079 0 396 15 080 0</p> <p>396 15 087 0 992 00 993 0 992 00 106 0 096 15 282 0 396 15 085 0 096 15 277 0 396 15 088 0 396 15 082 4</p> <p>296 15 282 0 (mit FA)</p>	<p>396 15 082 4</p> <p>992 01 510 0 992 01 353 0</p> <p>396 15 084 0 992 01 998 0 992 01 506 0</p> <p>396 15 281 4</p> <p>Für dünne Nähfäden ohne Kapsellüfter For fine sewing threads without bobbin case lifter</p>
---	---	---

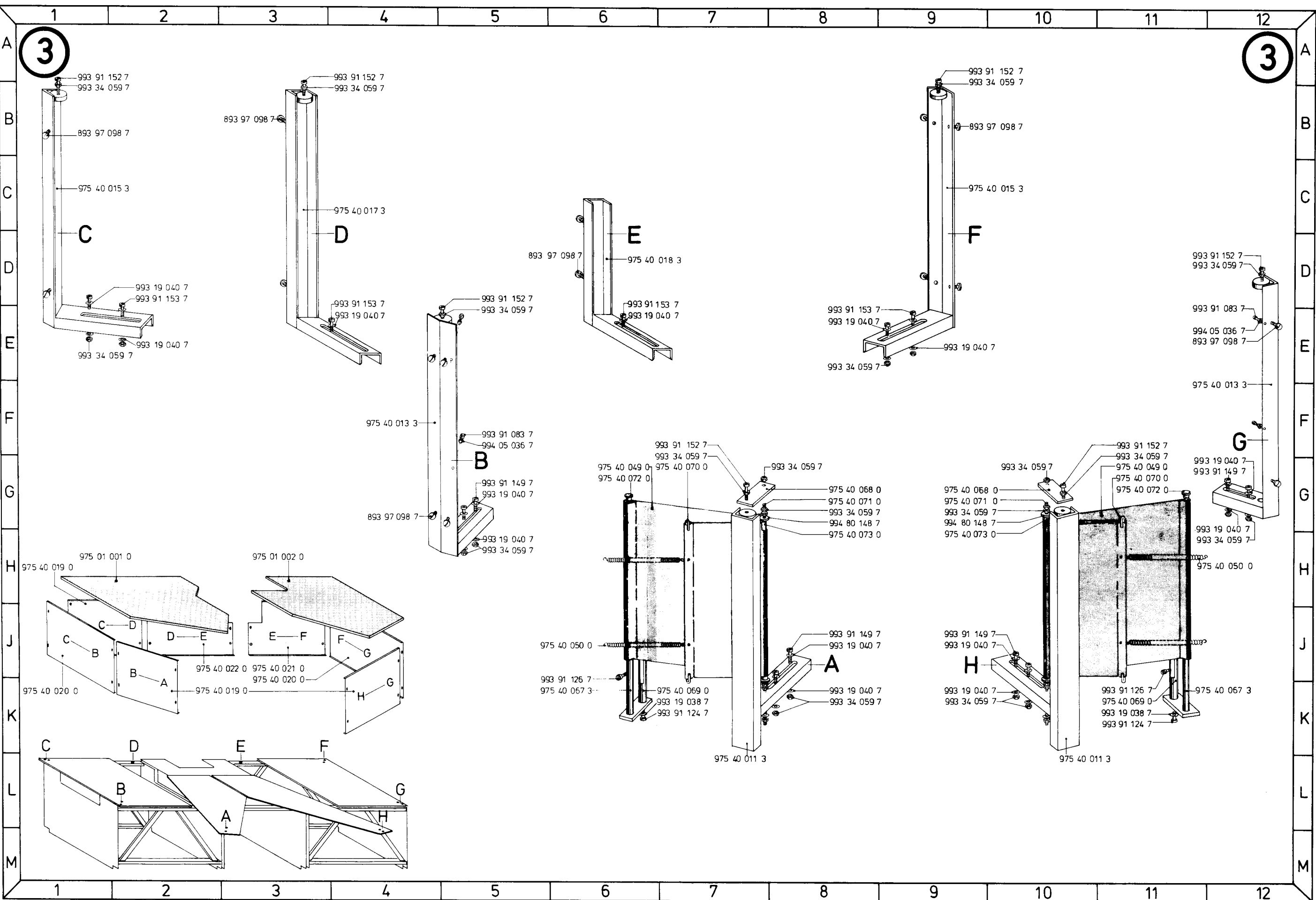

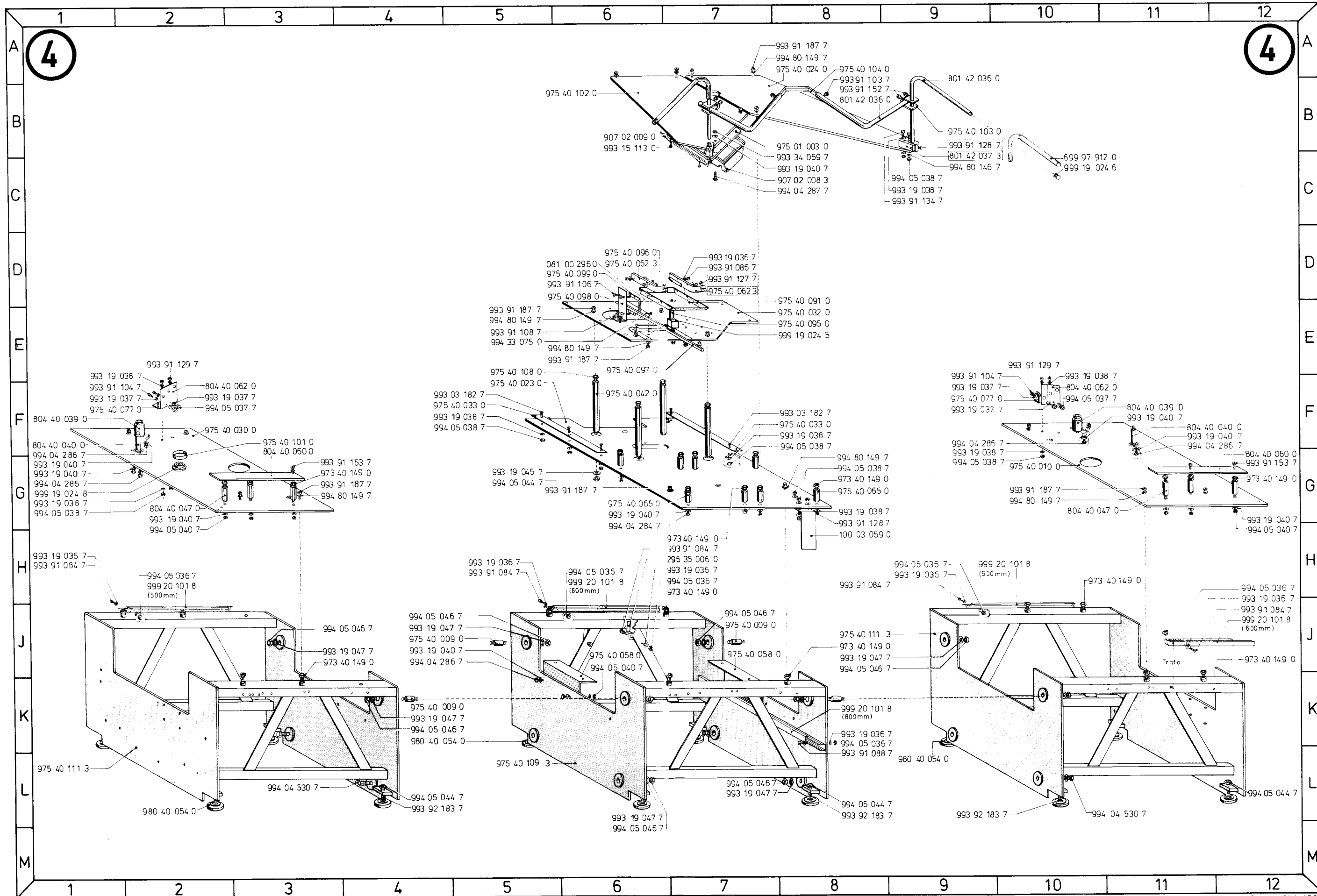

5

5

L = links / left / gauche / izquierda
R = rechts / right / droite / derecha

Schaltschrank 975 48 011 4

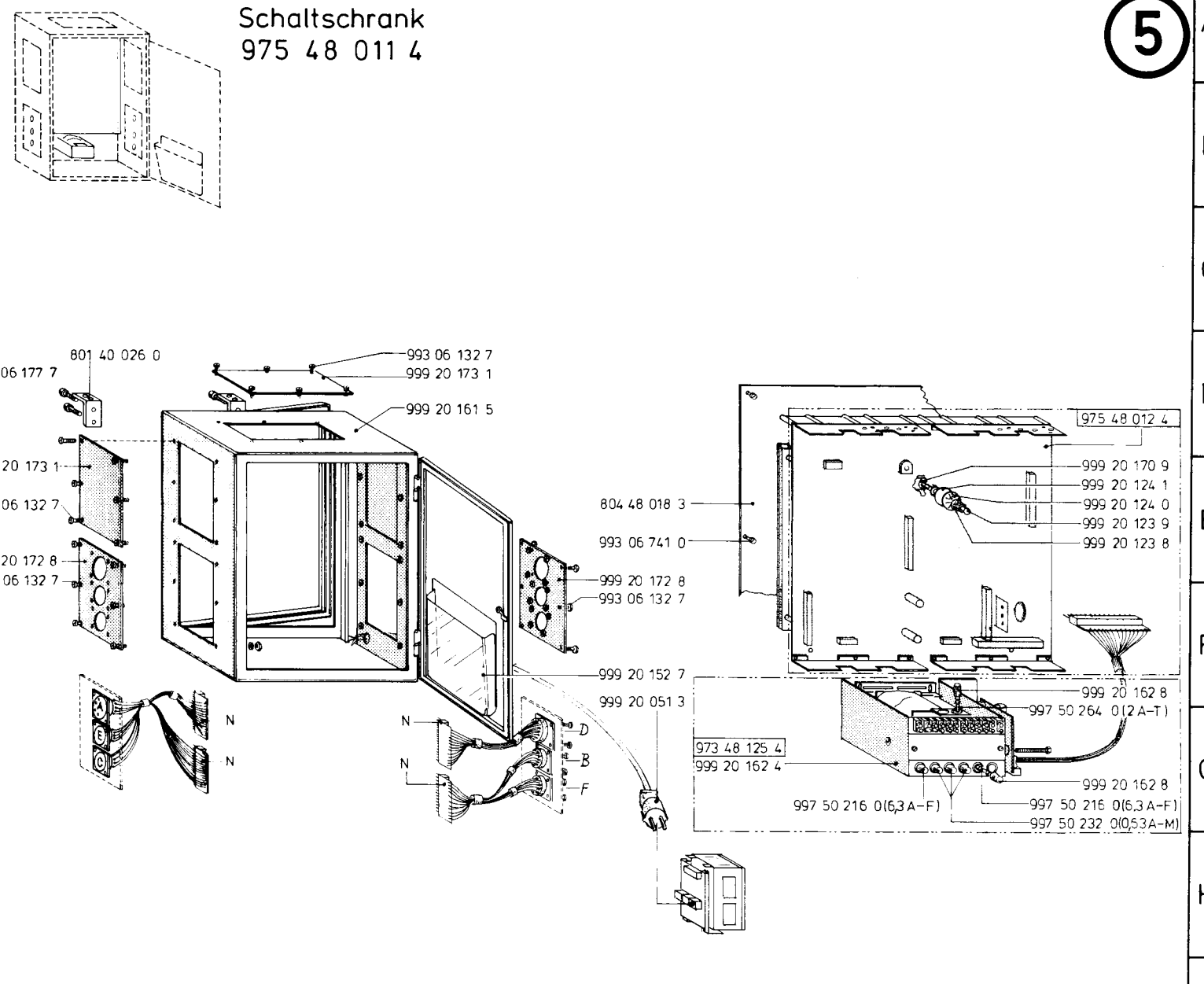
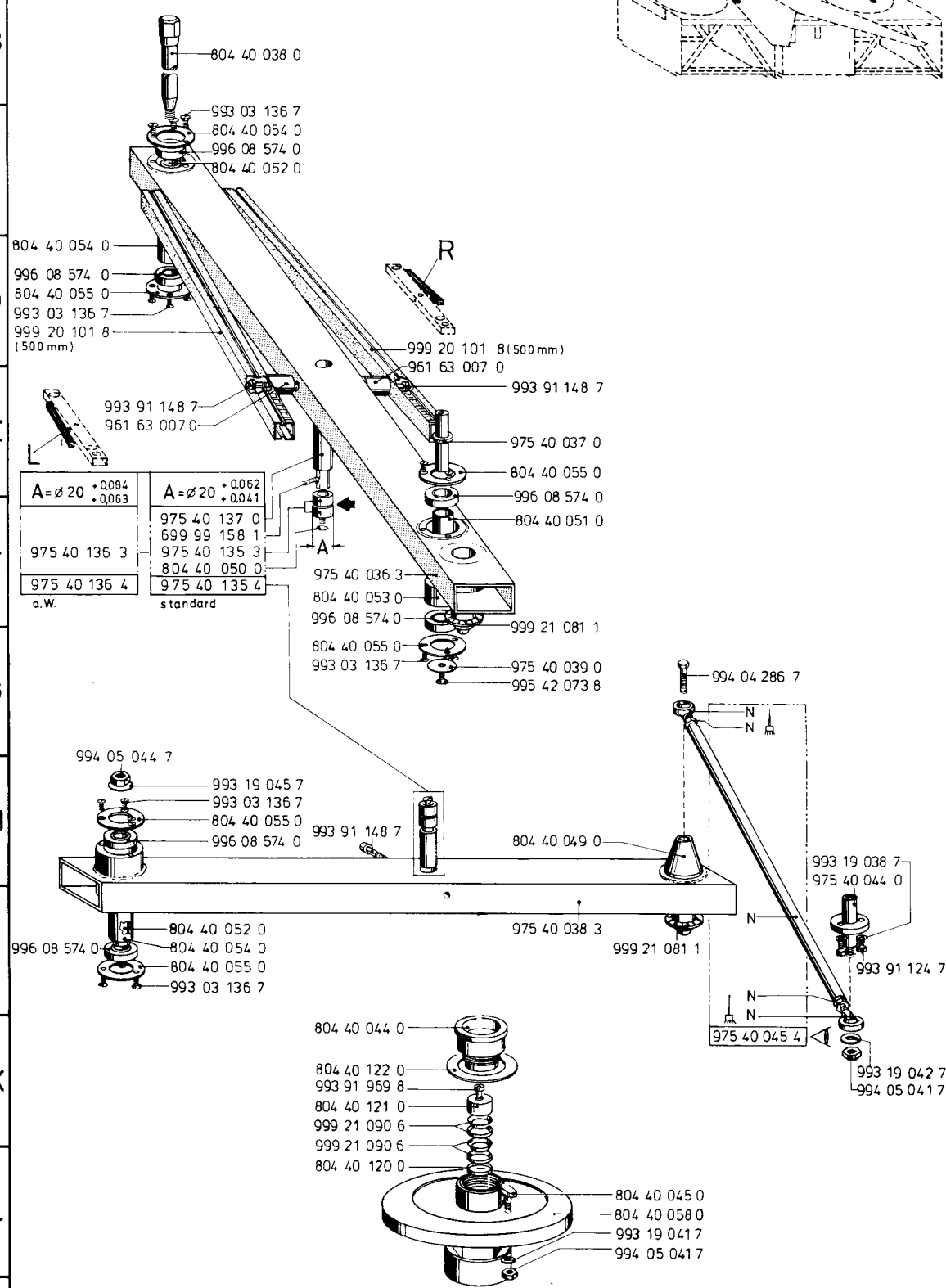

Vorschalttrafo

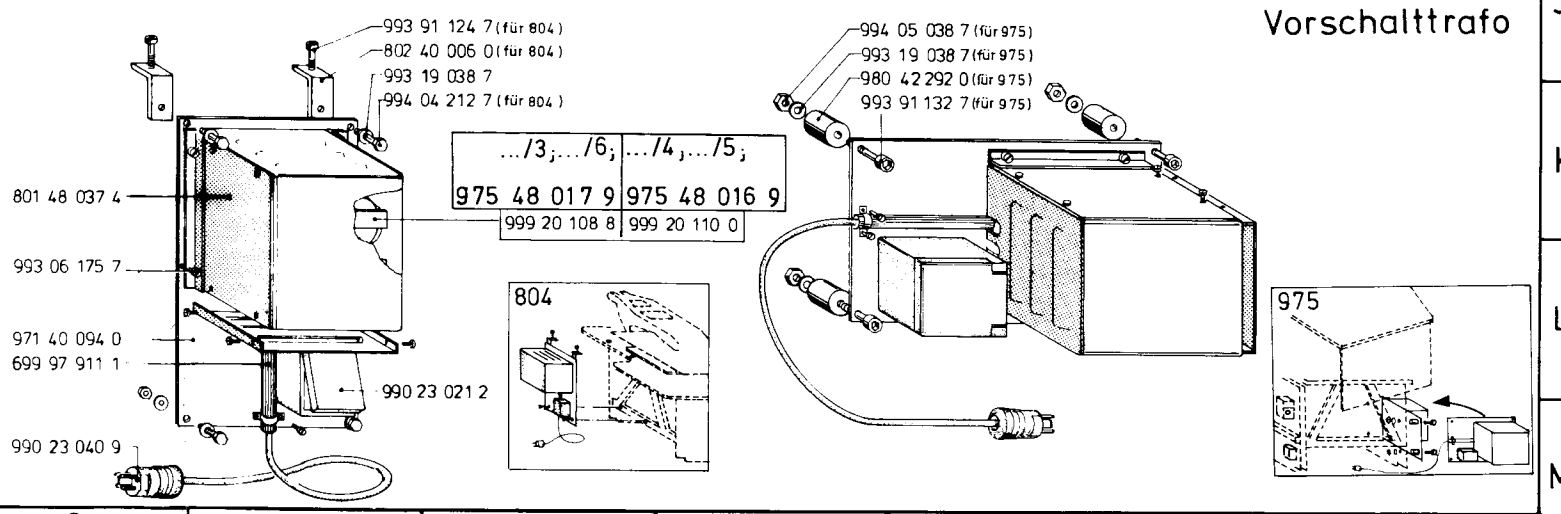

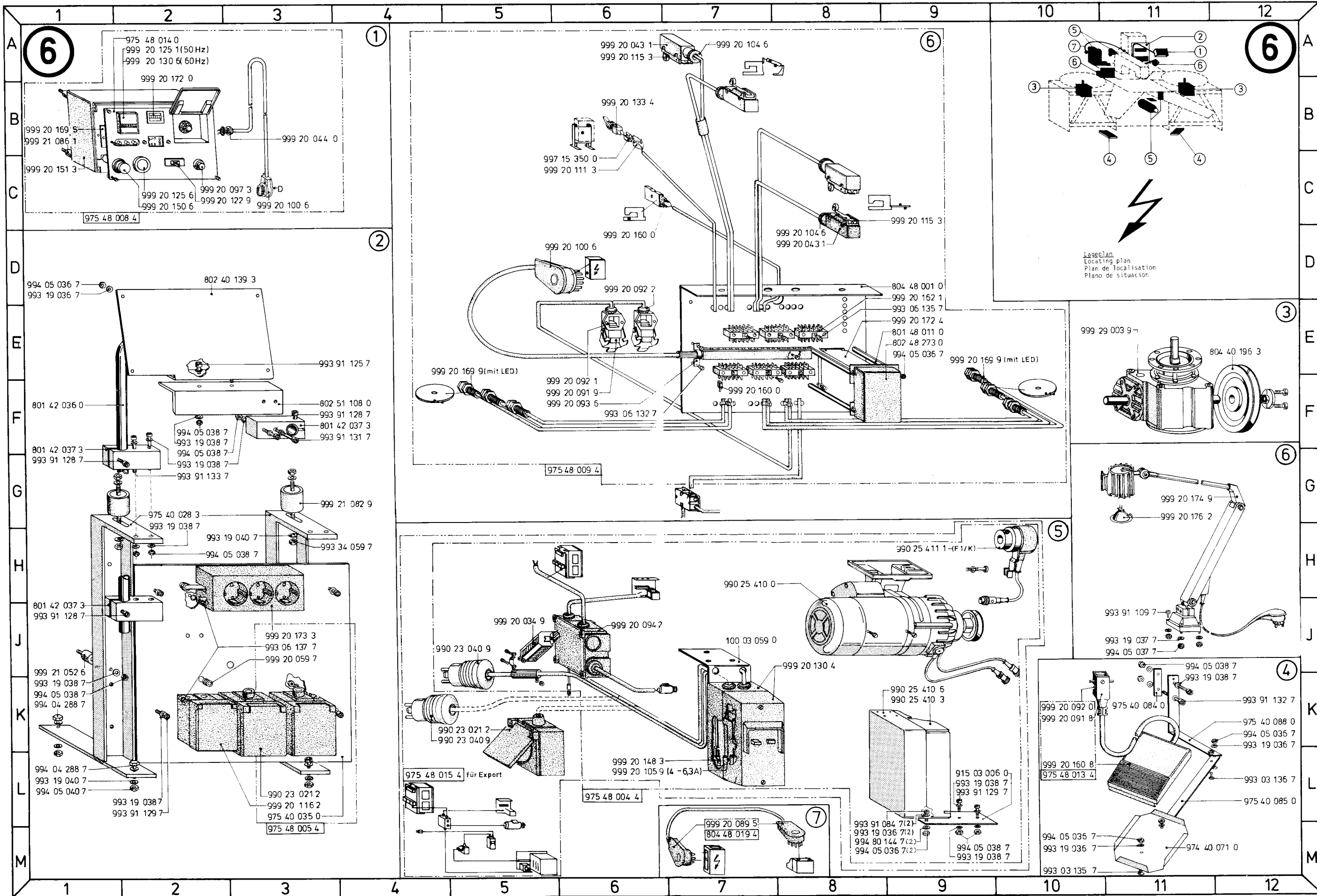

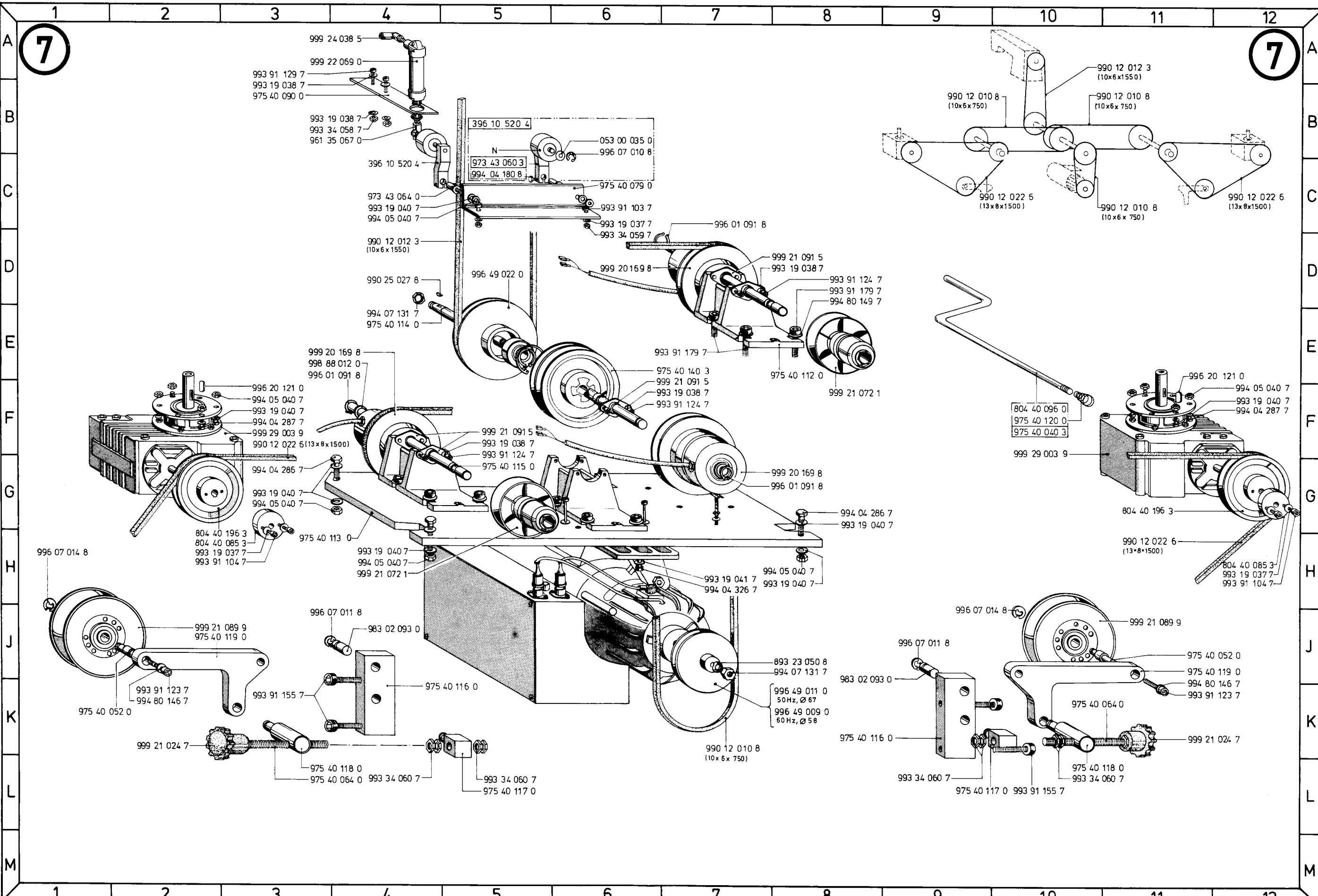

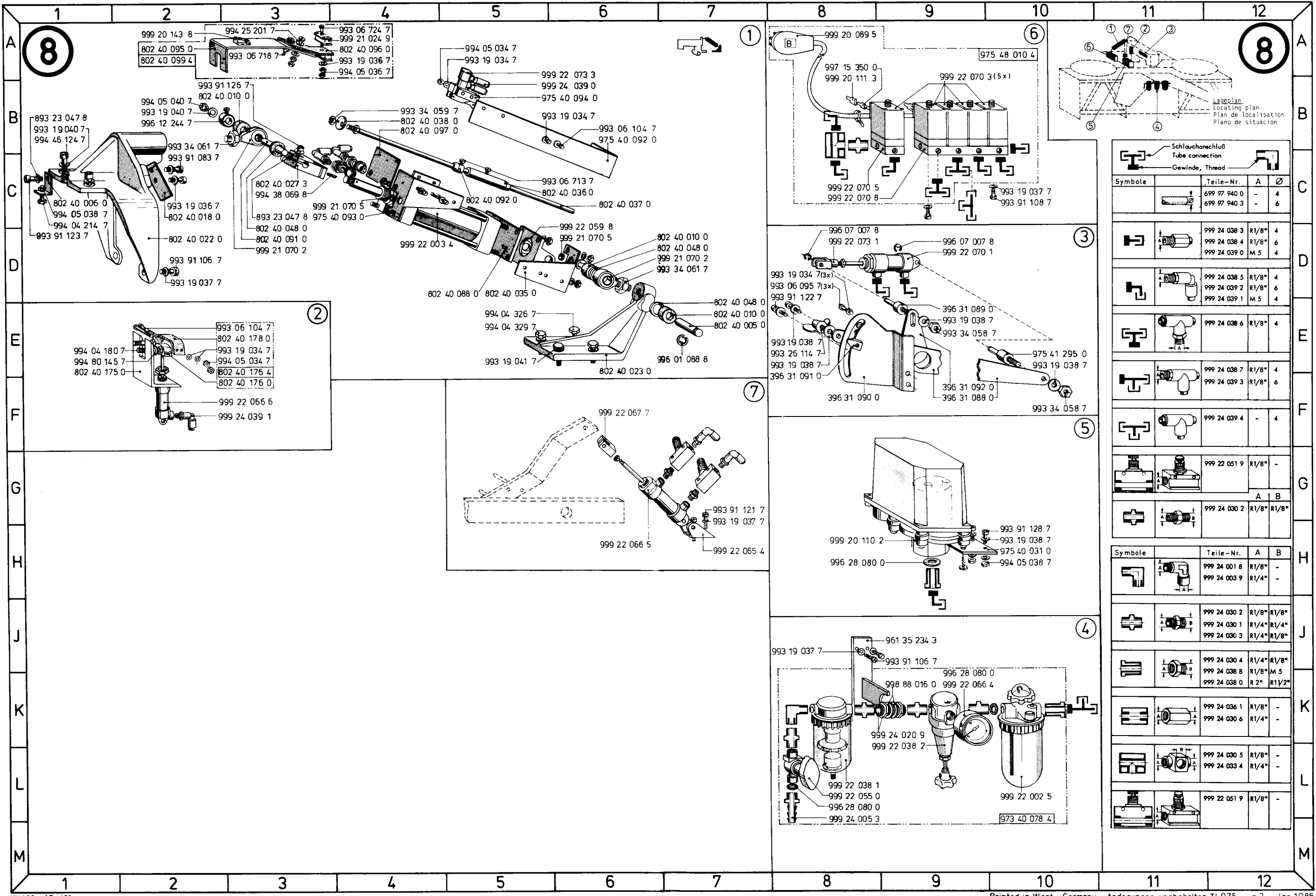

Schlauchschluß
Tube connection
Gewinde, Thread

Symbole	Teile-Nr.	A	B	Ø
	699 97 940 0	-	4	4
	699 97 940 3	-	6	6
	999 24 038 3	R1/8"	4	
	999 24 038 4	R1/8"	6	
	999 24 039 0	M 5	4	
	999 24 038 5	R1/8"	4	
	999 24 039 2	R1/8"	6	
	999 24 039 1	M 5	4	
	999 24 038 6	R1/8"	4	
	999 24 038 7	R1/8"	4	
	999 24 039 3	R1/8"	6	
	999 24 039 4	-	4	
	999 22 051 9	R1/8"	-	
	999 24 030 2	R1/8"	R1/8"	
	999 24 001 8	R1/8"	-	
	999 24 003 9	R1/4"	-	
	999 24 030 2	R1/8"	R1/8"	
	999 24 030 1	R1/4"	R1/4"	
	999 24 030 3	R1/4"	R1/8"	
	999 24 030 4	R1/4"	R1/8"	
	999 24 038 8	R1/8"	M 5	
	999 24 038 0	R 2"	R1/2"	
	999 24 036 1	R1/8"	-	
	999 24 030 6	R1/4"	-	
	999 24 030 5	R1/8"	-	
	999 24 033 4	R1/4"	-	
	999 22 051 9	R1/8"	-	

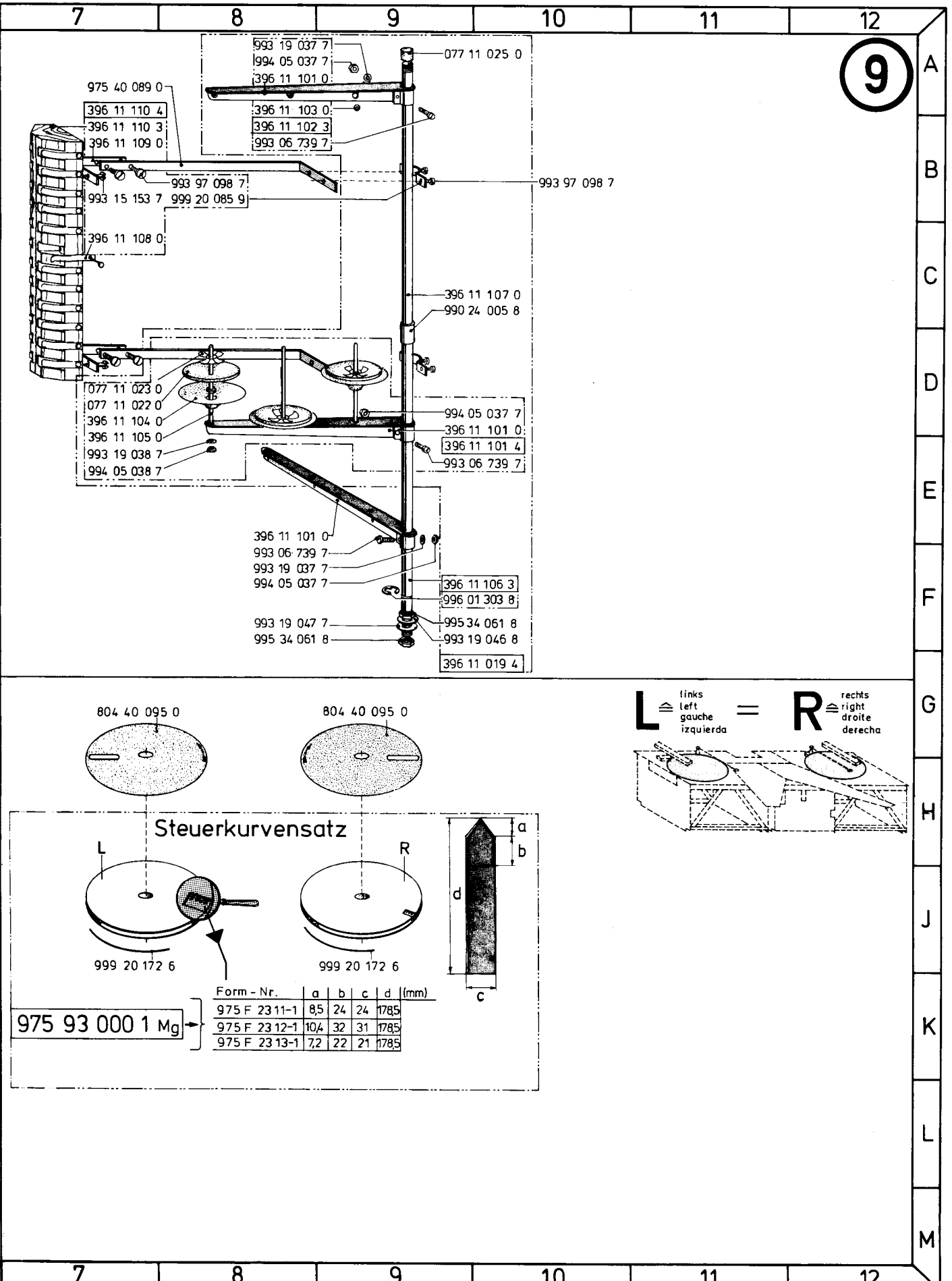
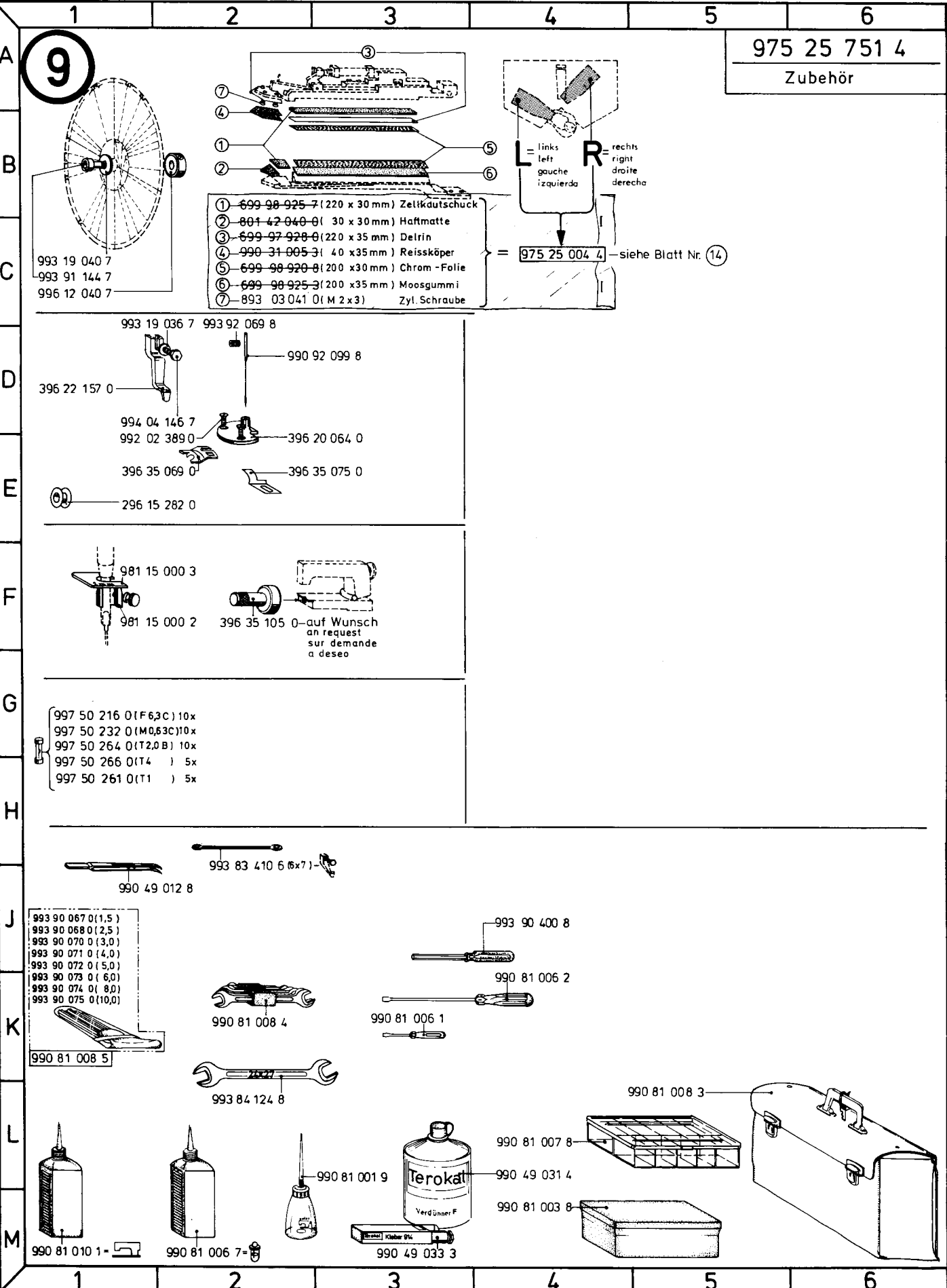

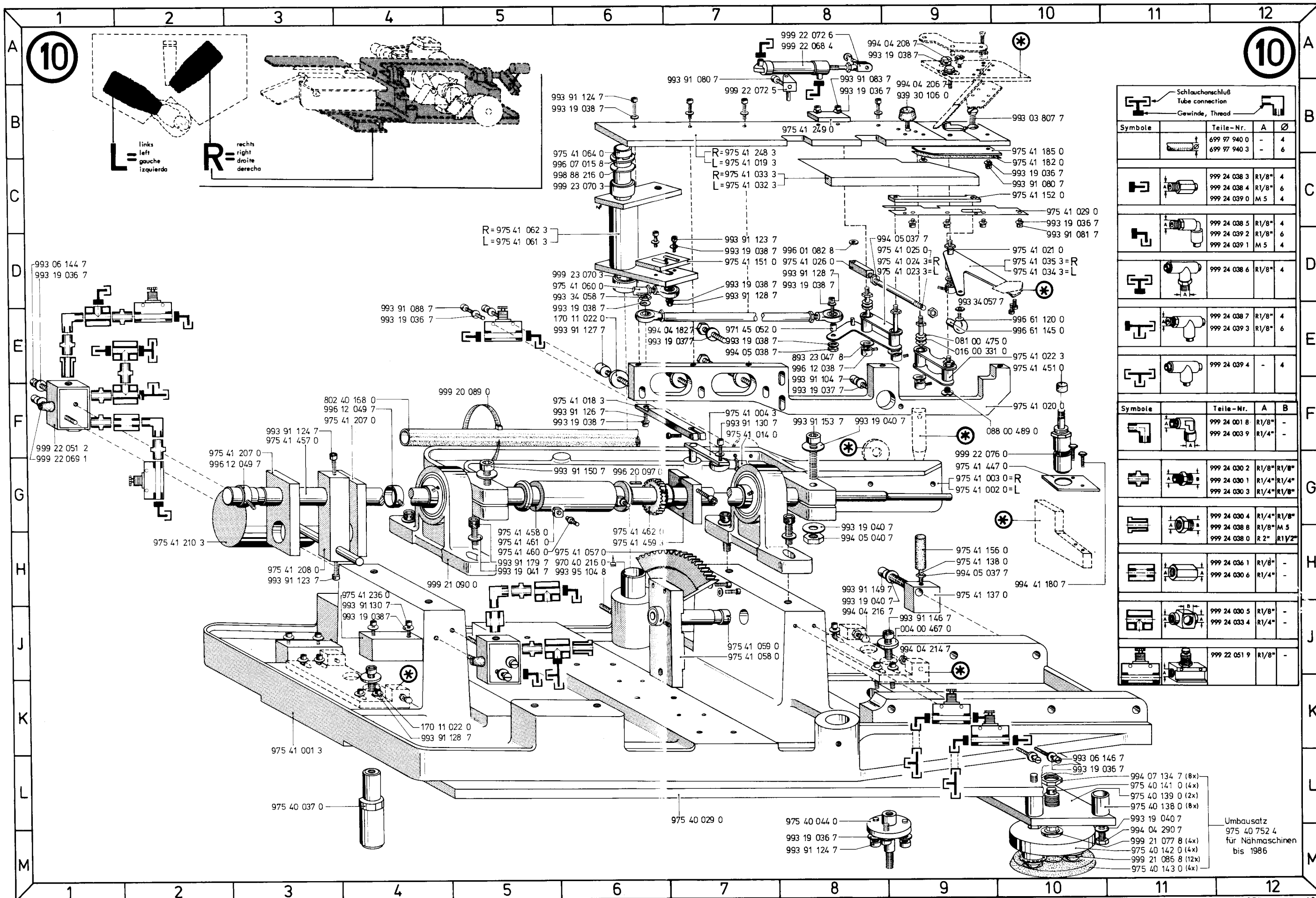

L = links
left
gauche
izquierda

R = rechts
right
droite
derecha

Symbol	Part No.	A	B
	699 97 940 0	-	4
	699 97 940 3	-	6
	999 24 038 3	R1/8"	4
	999 24 038 4	R1/8"	6
	999 24 039 0	M 5	4
	999 24 038 5	R1/8"	4
	999 24 039 2	R1/8"	6
	999 24 039 1	M 5	4
	999 24 038 6	R1/8"	4
	999 24 038 7	R1/8"	4
	999 24 039 3	R1/8"	6
	999 24 039 4	-	4
	999 24 001 8	R1/8"	-
	999 24 003 9	R1/4"	-
	999 24 030 2	R1/8"	R1/8"
	999 24 030 1	R1/4"	R1/4"
	999 24 030 3	R1/4"	R1/8"
	999 24 030 4	R1/4"	R1/8"
	999 24 038 8	R1/8"	M 5
	999 24 038 0	R 2"	R1/2"
	999 24 036 1	R1/8"	-
	999 24 030 6	R1/4"	-
	999 24 030 5	R1/8"	-
	999 24 033 4	R1/4"	-
	999 22 051 9	R1/8"	-

Part No.	Quantity
994 07 134 7 (8x)	8
975 40 141 0 (4x)	4
975 40 139 0 (2x)	2
975 40 138 0 (8x)	8
993 19 040 7	1
994 04 290 7	1
999 21 077 8 (4x)	4
975 40 142 0 (4x)	4
999 21 085 8 (12x)	12
975 40 143 0 (4x)	4

Umbausatz
975 40 752 4
für Nähmaschinen
bis 1986

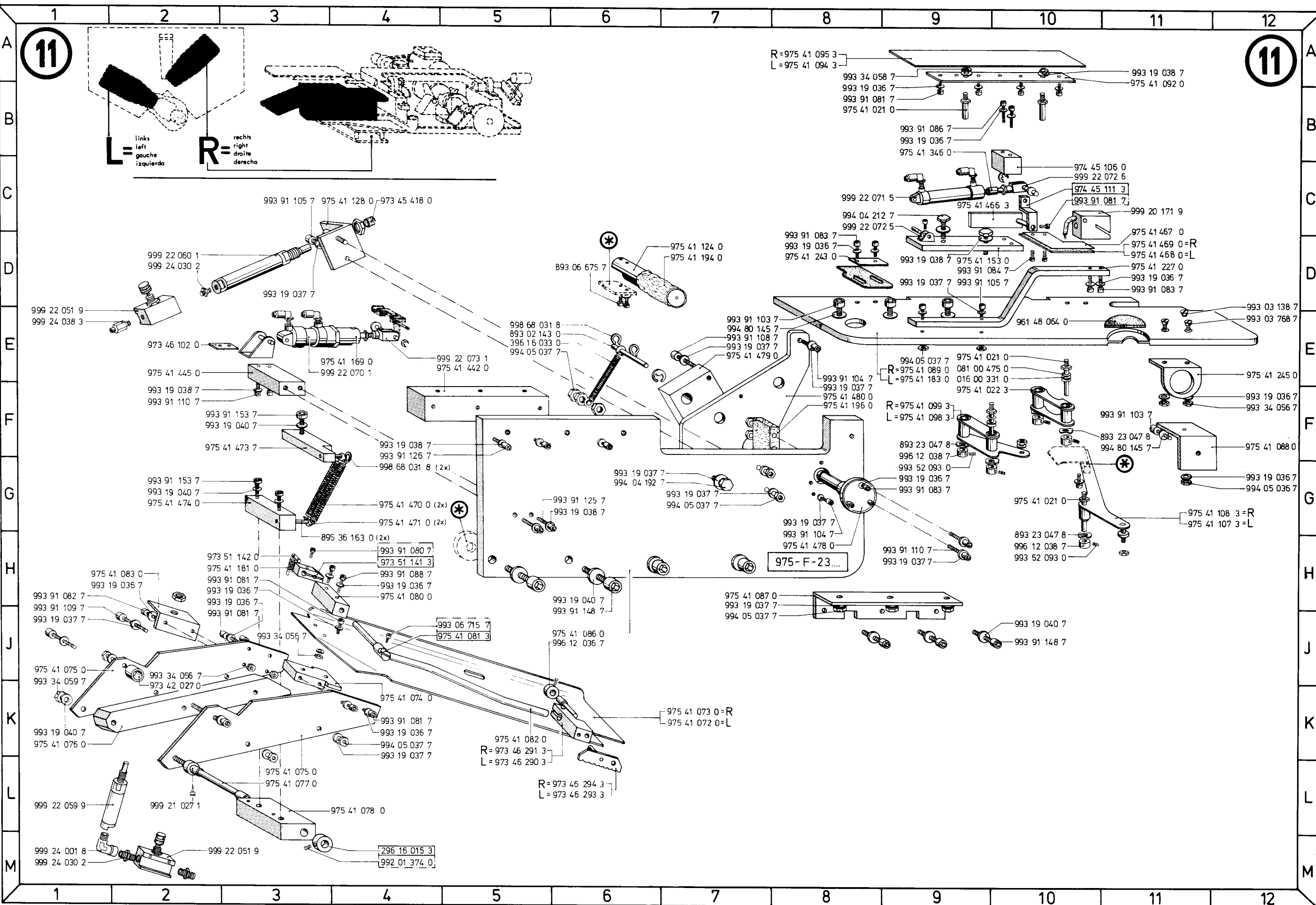

A.D.-10.1981 A.D.1.1.85

* Formteile siehe Bildtafel Nr.
 Pattern see diagram No.
 Pièces de forme voir tableau illustré N°
 Piezas de forma ver lámina de grabados N°

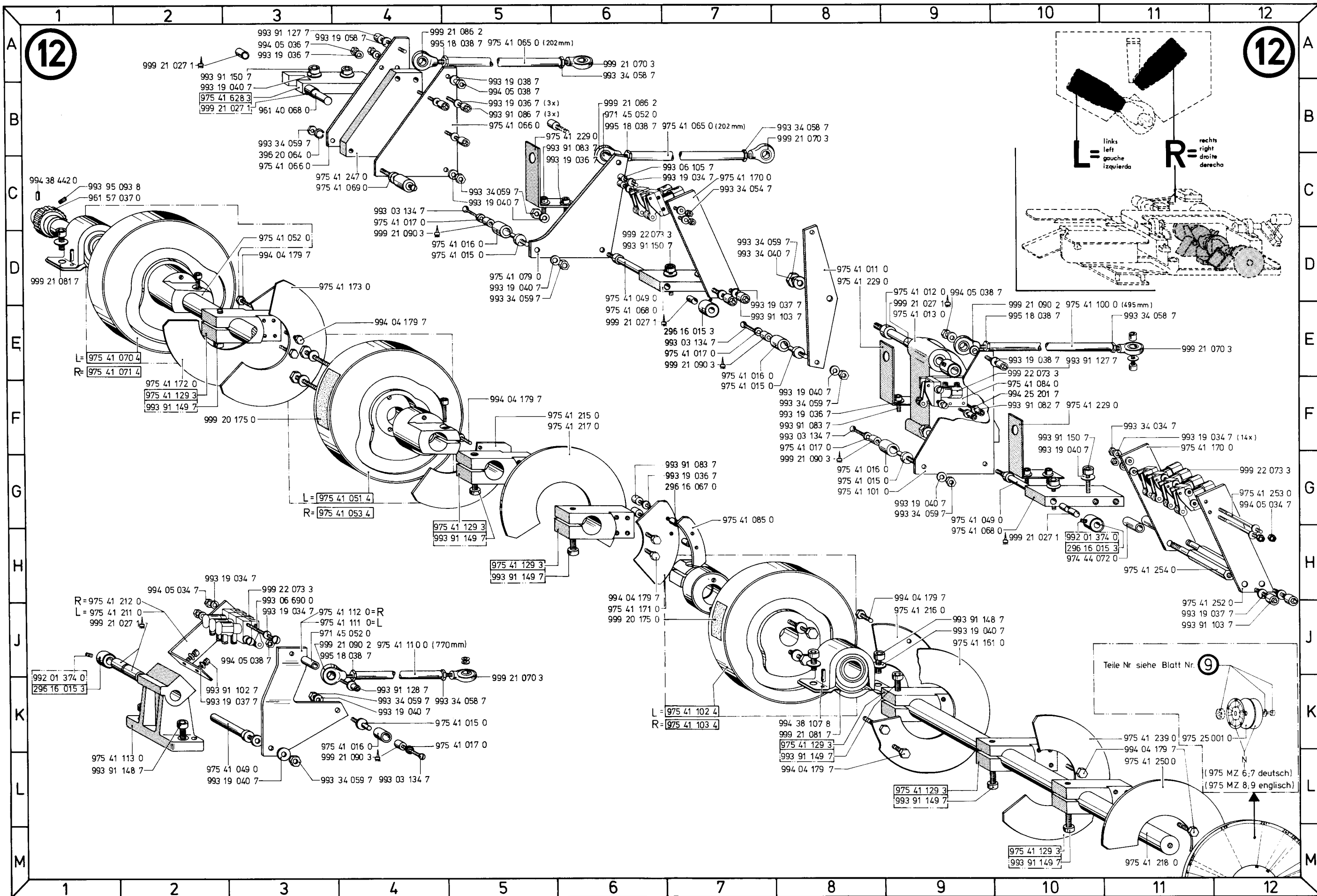

13

13

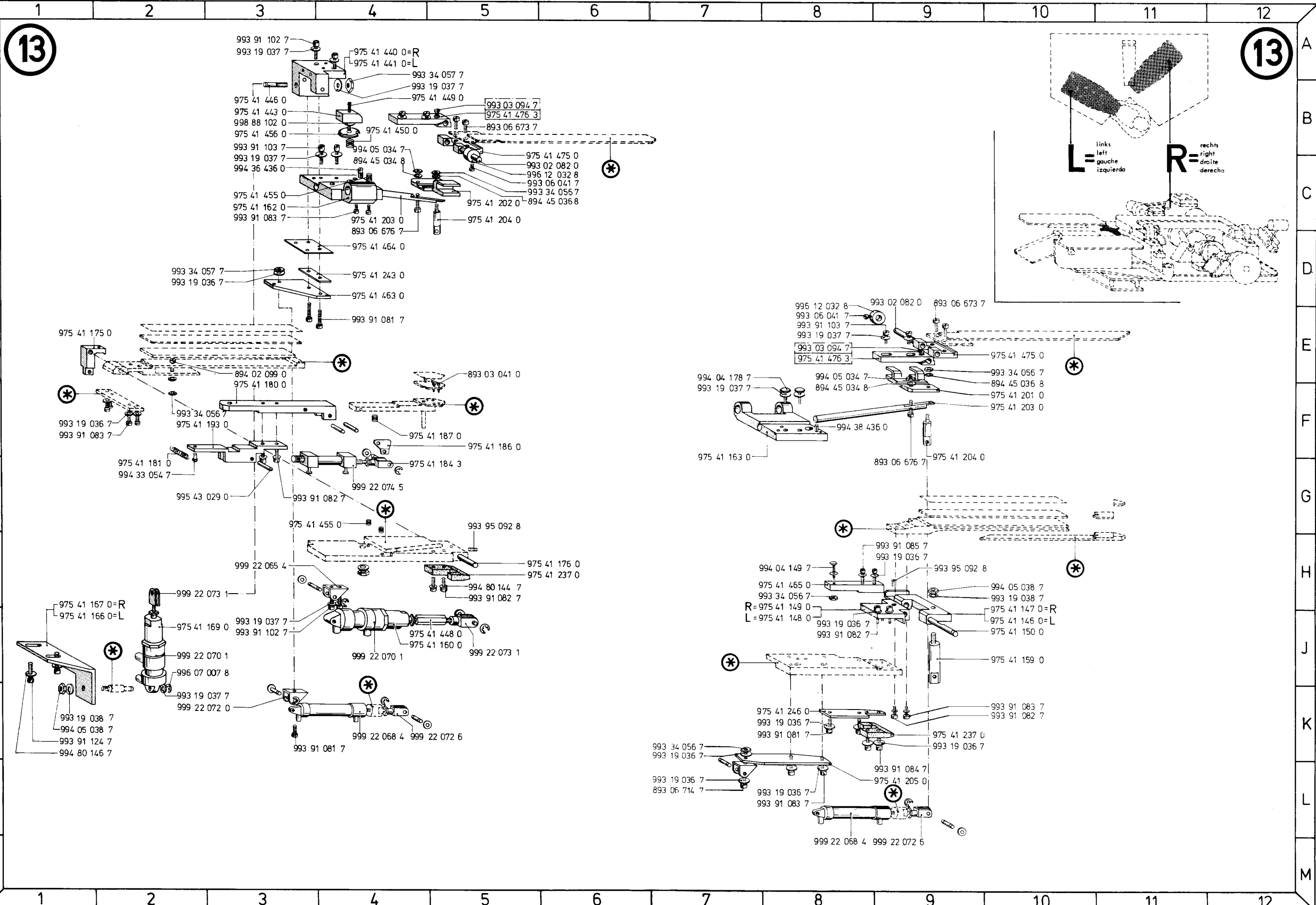

* — Formteile siehe Bildtafel Nr.
 Pattern see diagram No.
 Pièces de forme voir tableau illustré N°
 Piezas de forma ver lámina de grabados N°

14

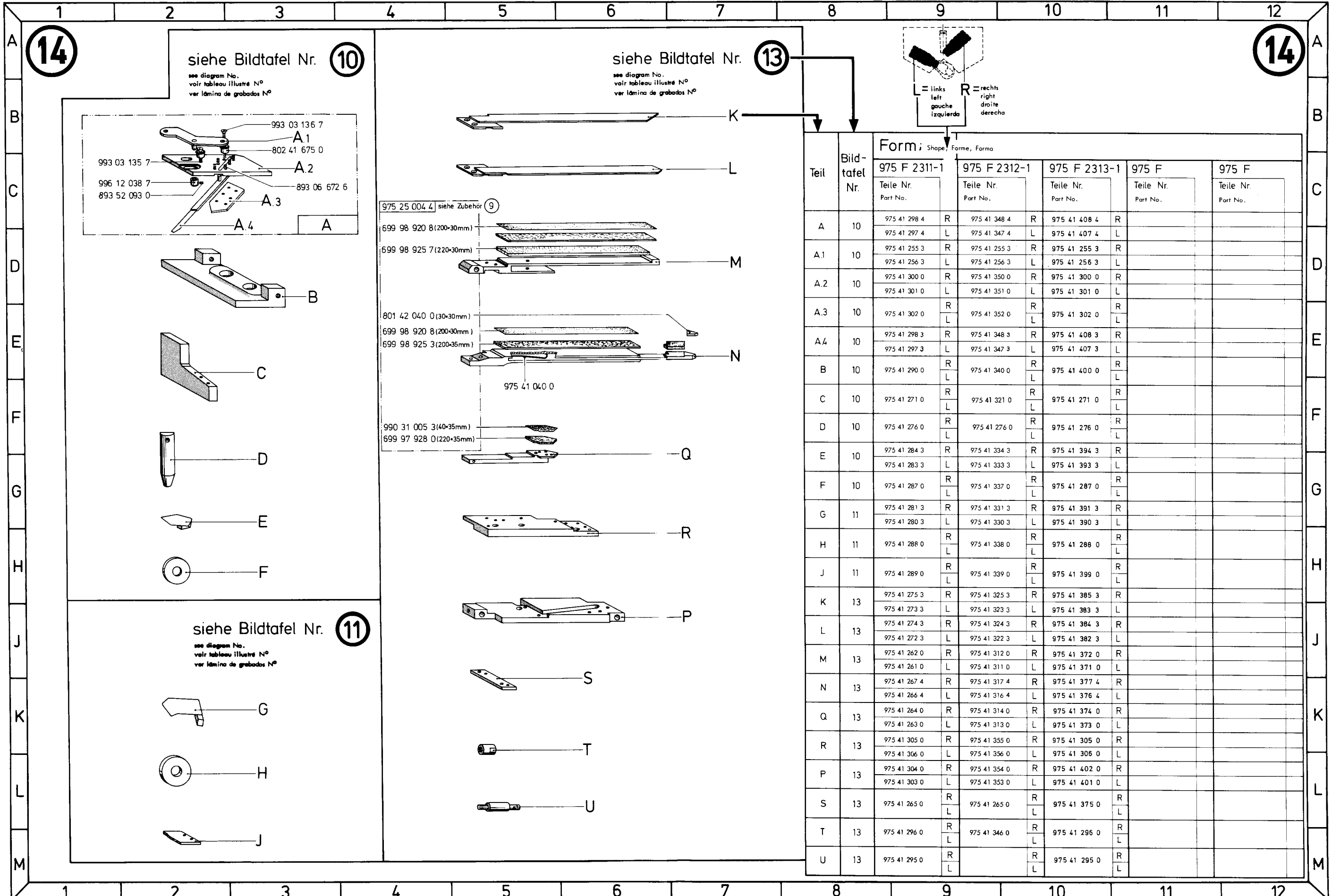

siehe Bildtafel Nr. **10**

see diagram No.
voir tableau illustré N°
ver lámina de grabados N°

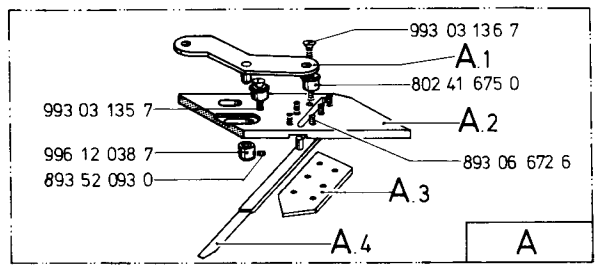

siehe Bildtafel Nr. **13**

see diagram No.
voir tableau illustré N°
ver lámina de grabados N°

975 25 004 4 siehe Zubehör **9**

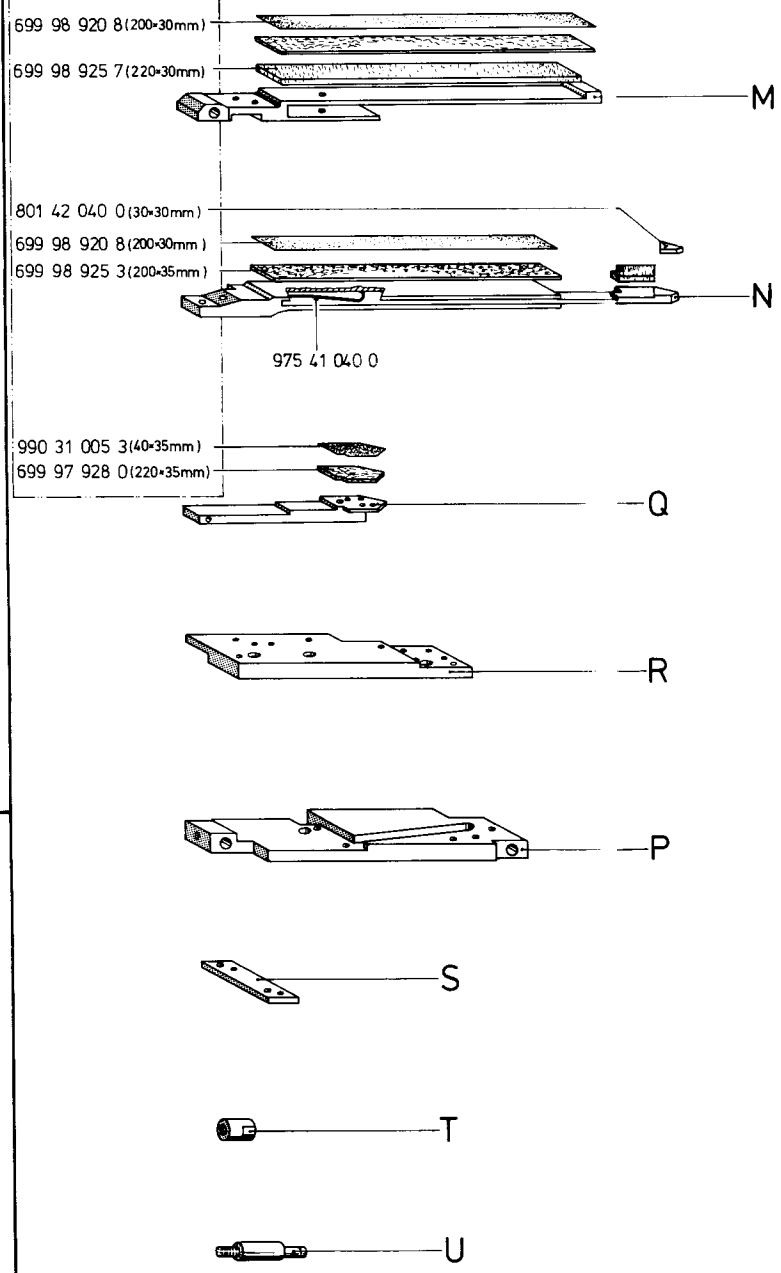

siehe Bildtafel Nr. **11**

see diagram No.
voir tableau illustré N°
ver lámina de grabados N°

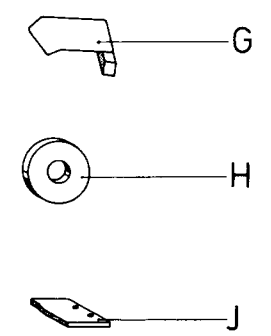

Form: Shape, Forme, Forma

Teil	Bildtafel Nr.	Form: Shape, Forme, Forma				
		975 F 2311-1	975 F 2312-1	975 F 2313-1	975 F	975 F
		Teile Nr. Part No.	Teile Nr. Part No.	Teile Nr. Part No.	Teile Nr. Part No.	Teile Nr. Part No.
A	10	975 41 298 4 R 975 41 297 4 L	975 41 348 4 R 975 41 347 4 L	975 41 408 4 R 975 41 407 4 L		
A.1	10	975 41 255 3 R 975 41 256 3 L	975 41 255 3 R 975 41 256 3 L	975 41 255 3 R 975 41 256 3 L		
A.2	10	975 41 300 0 R 975 41 301 0 L	975 41 350 0 R 975 41 351 0 L	975 41 300 0 R 975 41 301 0 L		
A.3	10	975 41 302 0 R 975 41 302 0 L	975 41 352 0 R 975 41 352 0 L	975 41 302 0 R 975 41 302 0 L		
A.4	10	975 41 298 3 R 975 41 297 3 L	975 41 348 3 R 975 41 347 3 L	975 41 408 3 R 975 41 407 3 L		
B	10	975 41 290 0 R 975 41 290 0 L	975 41 340 0 R 975 41 340 0 L	975 41 400 0 R 975 41 400 0 L		
C	10	975 41 271 0 R 975 41 271 0 L	975 41 321 0 R 975 41 321 0 L	975 41 271 0 R 975 41 271 0 L		
D	10	975 41 276 0 R 975 41 276 0 L	975 41 276 0 R 975 41 276 0 L	975 41 276 0 R 975 41 276 0 L		
E	10	975 41 284 3 R 975 41 283 3 L	975 41 334 3 R 975 41 333 3 L	975 41 394 3 R 975 41 393 3 L		
F	10	975 41 287 0 R 975 41 287 0 L	975 41 337 0 R 975 41 337 0 L	975 41 287 0 R 975 41 287 0 L		
G	11	975 41 281 3 R 975 41 280 3 L	975 41 331 3 R 975 41 330 3 L	975 41 391 3 R 975 41 390 3 L		
H	11	975 41 288 0 R 975 41 288 0 L	975 41 338 0 R 975 41 338 0 L	975 41 288 0 R 975 41 288 0 L		
J	11	975 41 289 0 R 975 41 289 0 L	975 41 339 0 R 975 41 339 0 L	975 41 399 0 R 975 41 399 0 L		
K	13	975 41 275 3 R 975 41 273 3 L	975 41 325 3 R 975 41 323 3 L	975 41 385 3 R 975 41 383 3 L		
L	13	975 41 274 3 R 975 41 272 3 L	975 41 324 3 R 975 41 322 3 L	975 41 384 3 R 975 41 382 3 L		
M	13	975 41 262 0 R 975 41 261 0 L	975 41 312 0 R 975 41 311 0 L	975 41 372 0 R 975 41 371 0 L		
N	13	975 41 267 4 R 975 41 266 4 L	975 41 317 4 R 975 41 316 4 L	975 41 377 4 R 975 41 376 4 L		
Q	13	975 41 264 0 R 975 41 263 0 L	975 41 314 0 R 975 41 313 0 L	975 41 374 0 R 975 41 373 0 L		
R	13	975 41 305 0 R 975 41 306 0 L	975 41 355 0 R 975 41 356 0 L	975 41 305 0 R 975 41 306 0 L		
P	13	975 41 304 0 R 975 41 303 0 L	975 41 354 0 R 975 41 353 0 L	975 41 402 0 R 975 41 401 0 L		
S	13	975 41 265 0 R 975 41 265 0 L	975 41 265 0 R 975 41 265 0 L	975 41 375 0 R 975 41 375 0 L		
T	13	975 41 296 0 R 975 41 296 0 L	975 41 346 0 R 975 41 346 0 L	975 41 296 0 R 975 41 296 0 L		
U	13	975 41 295 0 R 975 41 295 0 L		975 41 295 0 R 975 41 295 0 L		

15

Pick-up 3-1
550 51 752 4

15

L = links
gauche
izquierda
R = rechts
drecht
derecha

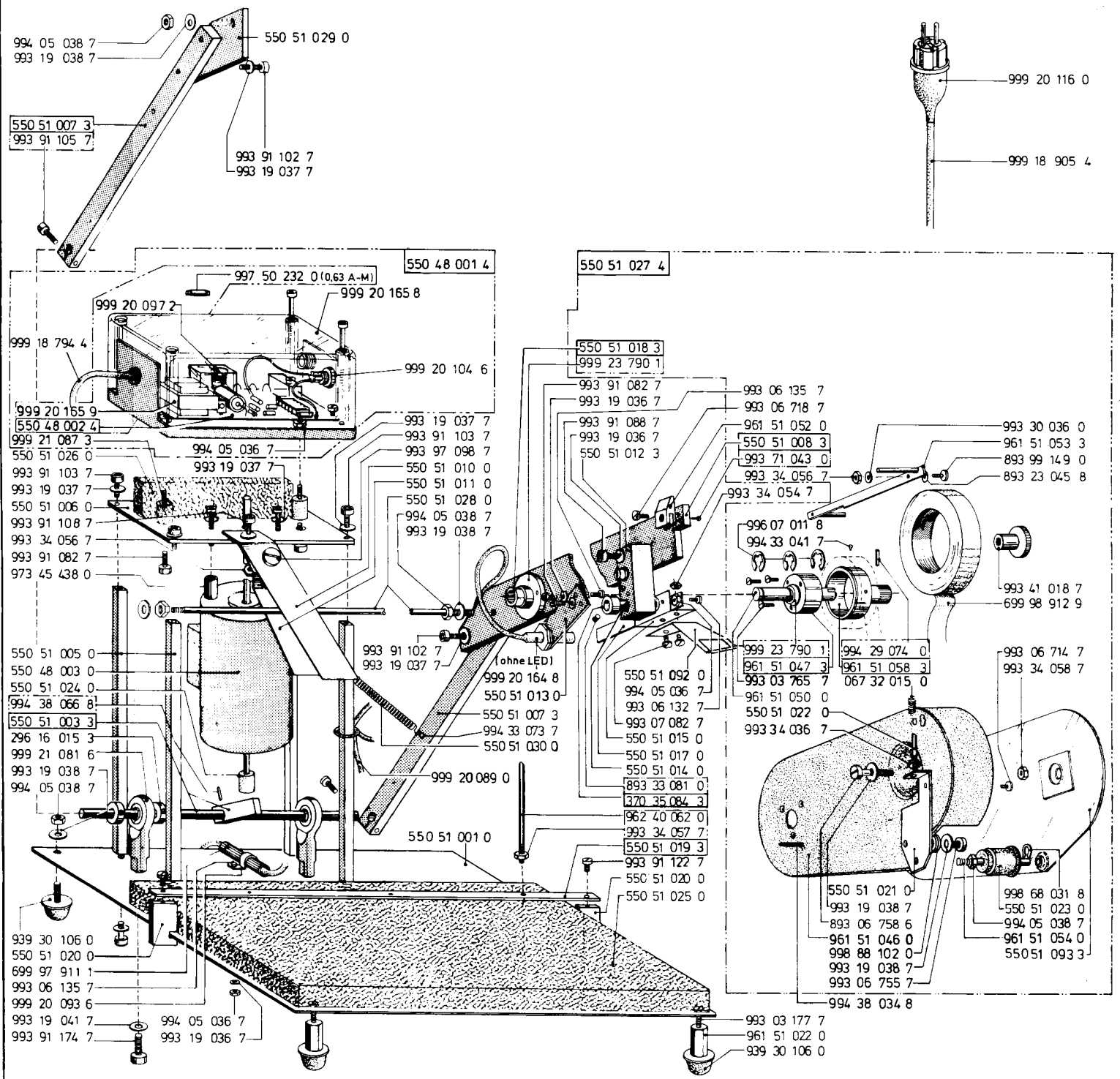
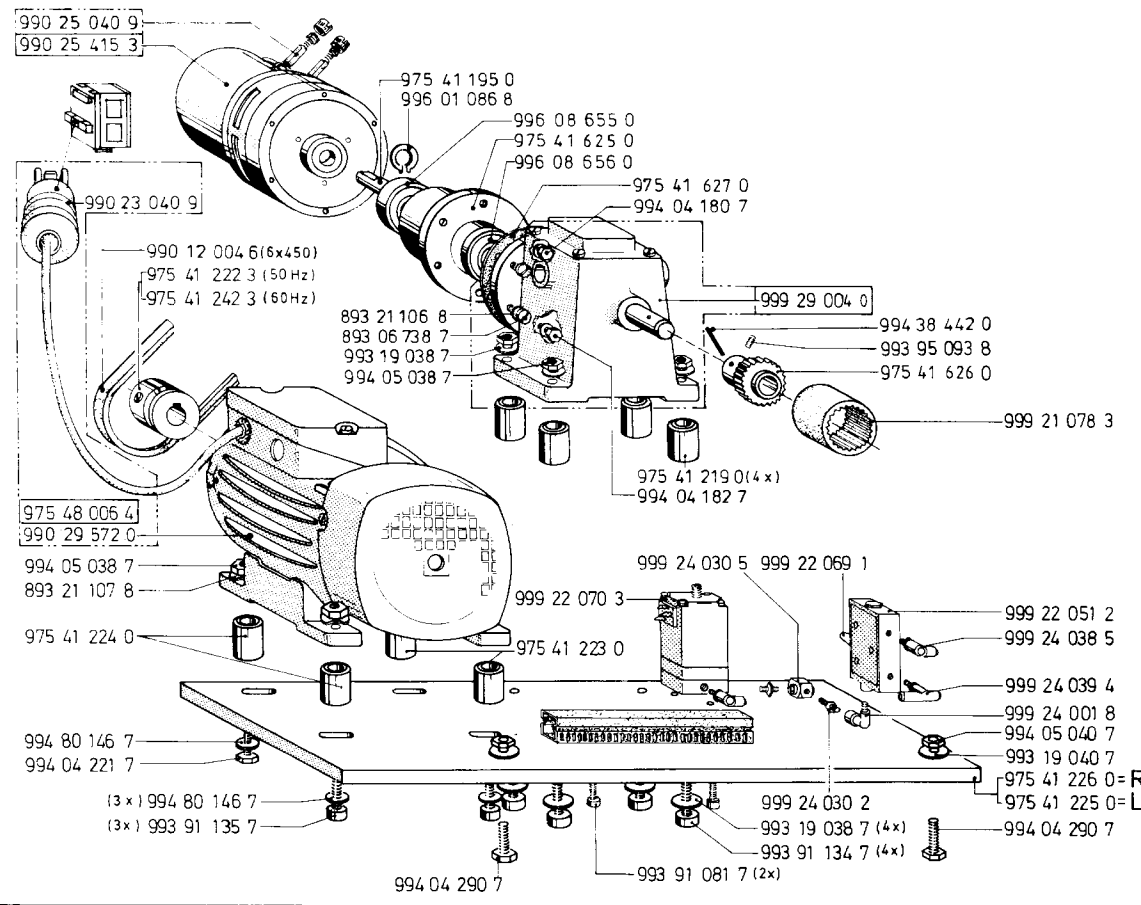
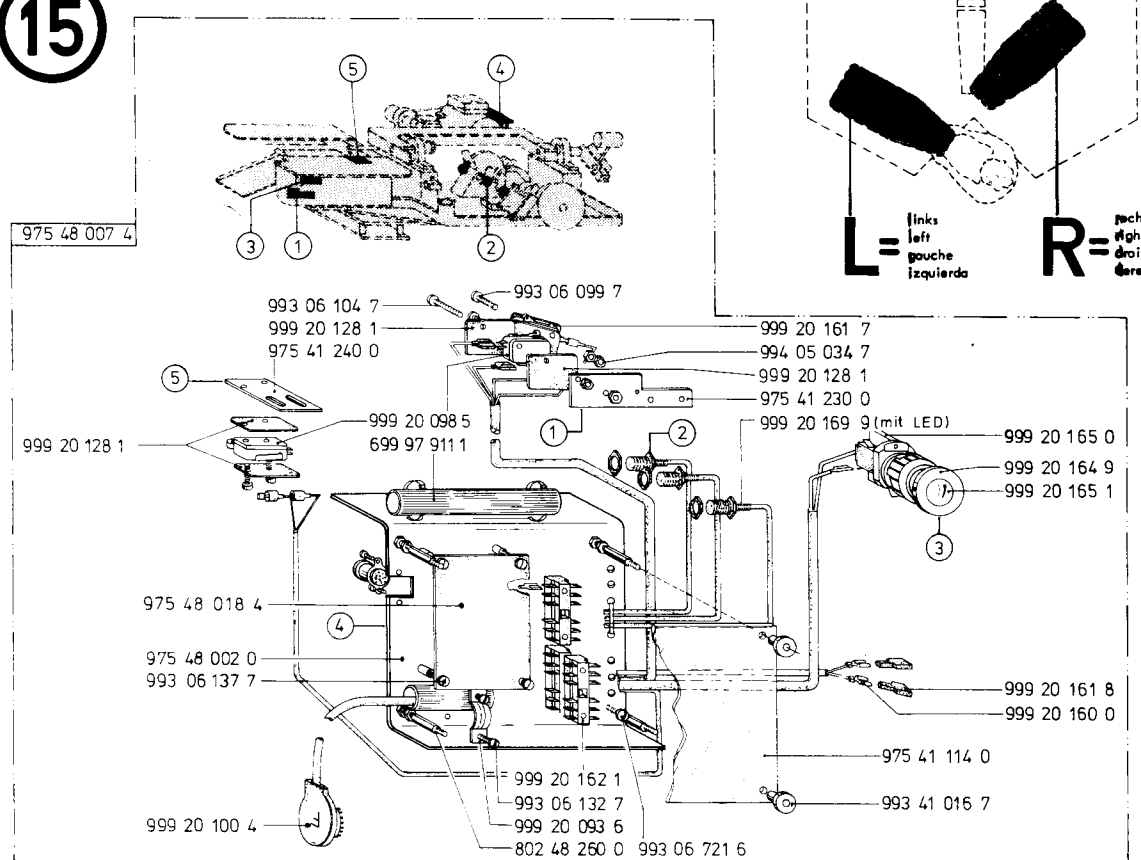

Ersatzteilliste. Spare parts. Pièces de rechange. Piezas de repuesto.

Teile-Nr.	Benennung	Teile-Nr.	Benennung	Teile-Nr.	Benennung	Teile-Nr.	Benennung	Teile-Nr.	Benennung	Teile-Nr.	Benennung
	11K6;12A3;12B5;12C6; 12F8;12G7;13A2;13B2; 13D2;13F1;13H8;13H9; 13K8;13K9;13L7;13L8; 15F9;15L7		11J2;13C6; 13E10;13F2;13H8; 13L7;15G6;15G10	993 91 088 7 ZYL.SCHR.MOX25 4L8;10E4; 11B9;11H4;15F9		3J8;3J9;5E1; 5E3;5H3;10H8; 12F2;12H5;12L8; 12L9;12M10	994 04 221 7 6KT.SCHR.MOX55 15L1 994 04 284 7 6KT.SCHR.MOX25 4G6 994 04 286 7 6KT.SCHR.MOX30 4E5;4F1; 4F9;4F11;4G1;4J4 5G5;7G8	994 27 171 0 ZYL.KERBSTIFT 8X32 1K8 994 29 074 0 PASSKERBSTIFT 3X14 15H11 994 29 077 0 PASSKERBSTIFT 3X20 1J5 994 33 041 7 HALBRD.KERBNAG.2X4 15G10 994 33 054 7 HALBRD.KERBNAG.2,3X7 13G2 994 33 071 0 HALBRD.KERBNAG.3X4 2G5 994 33 073 7 HALBRD.KERBNAG.3X6 15J9 994 33 075 0 HALBRD.KERBNAG.3X8 4E5 994 38 022 7 SPANNHUELSE 1,5X6 1D3 994 38 034 8 SPANNHUELSE 2X10 15L11 994 38 063 8 SPANNHUELSE 3X8 7F1 994 38 066 8 SPANNHUELSE 3X14 15J6 994 38 069 8 SPANNHUELSE 3X20 8C3 994 38 082 8 SPANNHUELSE 4X6 2D9 994 38 087 8 SPANNHUELSE 4X16 2D4 994 38 106 8 SPANNHUELSE 5X14 1J3 994 38 107 8 SPANNHUELSE 5X16 2K9;2K12; 12K8			
993 19 037 7 SCHEIBE 5,3 2E3;2L9;2L10; 2L11;2L12;4F2;4F9; 6J11;7H3;7H12;8C10; 8D2;8H7;8J8;9A8;9F8; 10E7;10F8;11J1;11D2; 11K4;11G6;11G7;11J7; 11E8;11G8;12J11;12K3; 13A3;13B5;13C3;13E8; 13J3;13K2;16D7;15F7; 15F8;15G6;15H8	993 34 057 7 6KT.MUTTER M5 1H5;10D9; 13A5;13B2; 13D2;15K10	993 91 102 7 ZYL.SCHR.MOX10 1J10;12K2 13A3;13J3;15D7;15H8	993 91 103 7 ZYL.SCHR.MOX12 1G2;1J2; 2D5;4A8;11F11; 12E8;12J11;13E8; 15F8;15G6	993 91 150 7 ZYL.SCHR.MOX35 10G6; 12A3;12D6;12F10	993 91 152 7 ZYL.SCHR.MOX45 3A1;3A4; 3A9;3D5;3D12; 3F7;3F11;4B8	994 04 287 7 6KT.SCHR.MOX35 4C8;7F3; 7F12;7G3 994 04 288 7 6KT.SCHR.MOX40 6K1;6L1 994 04 290 7 6KT.SCHR.MOX50 10M11;15M3 15M5	994 33 041 7 HALBRD.KERBNAG.2X4 15G10 994 33 054 7 HALBRD.KERBNAG.2,3X7 13G2 994 33 071 0 HALBRD.KERBNAG.3X4 2G5 994 33 073 7 HALBRD.KERBNAG.3X6 15J9 994 33 075 0 HALBRD.KERBNAG.3X8 4E5 994 38 022 7 SPANNHUELSE 1,5X6 1D3 994 38 034 8 SPANNHUELSE 2X10 15L11 994 38 063 8 SPANNHUELSE 3X8 7F1 994 38 066 8 SPANNHUELSE 3X14 15J6 994 38 069 8 SPANNHUELSE 3X20 8C3 994 38 082 8 SPANNHUELSE 4X6 2D9 994 38 087 8 SPANNHUELSE 4X16 2D4 994 38 106 8 SPANNHUELSE 5X14 1J3 994 38 107 8 SPANNHUELSE 5X16 2K9;2K12; 12K8				
993 19 038 7 SCHEIBE 6,4 1L9;2H7;2H10; 3K7;3K11;4C9;4E2; 4E10;4F5;4F8;4G1; 4G8;4G9;5H5;5J10; 5K8;6K1;6F2;6G2; 6H2;6L2;6L9;6M9;6K11; 7B3;7B4;7D8;7F7;7F7; 7H4;7H9;7J8;7L4; 7L11;8E8;8E9;10E6; 10E7;10F6;10J4; 11A11;11D9;11F2; 11F4;11G6;12B5; 12E10;13H10;13K1; 15C6;15G8;15J2;15J6; 15K12;15L11;15M5	993 34 058 7 6KT.MUTTER M6 7B4;7H4;8E9; 8E10;10D6;11A8; 12A4;12A6;12B8; 12E11;15H12	993 91 104 7 ZYL.SCHR.MOX16 2L9;2L10; 2L11;2L12;4E9; 4F2;7H3;7H12; 10E8;11F8;11E7; 11G8	993 91 105 7 ZYL.SCHR.MOX18 11C3;11D9; 15D6 993 91 106 7 ZYL.SCHR.MOX20 4D6;8D2;8J9 993 91 108 7 ZYL.SCHR.MOX25 4E5;8C10; 11E7;15G6 993 91 109 7 ZYL.SCHR.MOX30 2E3;6J11; 993 91 110 7 ZYL.SCHR.MOX35 11F2;11J1 993 91 121 7 ZYL.SCHR.MOX8 8H7 993 91 122 7 ZYL.SCHR.MOX10 7F1;8D8; 15K10	993 91 155 7 ZYL.SCHR.MOX60 4A8;7K3; 7L10 993 91 156 7 ZYL.SCHR.MOX65 4G5 993 91 174 7 ZYL.SCHR.MOX16 15L6 993 91 178 7 ZYL.SCHR.MOX25 7F4 993 91 179 7 ZYL.SCHR.MOX30 7D8;7E7; 10G5 993 91 181 7 ZYL.SCHR.MOX40 7E4 993 91 185 7 ZYL.SCHR.MOX60 1K8 993 91 187 7 ZYL.SCHR.MOX70 4A8;4E5; 4G3;4G10 993 91 969 8 ZYL.SCHR.MOX35 5K3 993 92 069 8 GEW.STIFT M3X3 1G2 993 92 099 8 GEW.STIFT M5X6 1C8 993 92 183 7 GEW.STIFT M16X70 4L4;4L8 4L9 993 95 092 8 GEW.STIFT M5X6 13G5;13H9 993 95 093 8 GEW.STIFT M5X8 12C1;15J5 993 95 104 8 GEW.STIFT M6X10 10H6 993 96 141 0 FL.KOPFSCHR.M4X12 1F5 993 96 158 7 FL.KOPFSCHR.M5X6 1G5 993 96 160 0 FL.KOPFSCHR.M5X10 1F4 993 96 160 7 FL.KOPFSCHR.M5X10 1F4 993 97 098 7 FL.KOPFSCHR.M4X8 15F8 993 97 098 7 FL.KOPFSCHR.M4X8 9B8;9B10 994 04 109 8 6KT.SCHR.MOX12 1C1 994 04 146 7 6KT.SCHR.MOX8 1F1;9D1 994 04 149 7 6KT.SCHR.MOX12 13H8 994 04 149 8 6KT.SCHR.MOX12 1E1 994 04 150 7 6KT.SCHR.MOX16 2F5 994 04 178 7 6KT.SCHR.MOX10 13E7 994 04 179 7 6KT.SCHR.MOX12 12D3;12E4; 12F5;12H6;12H9;12K10 994 04 180 7 6KT.SCHR.MOX16 8E1;10H10; 15H4 994 04 180 8 6KT.SCHR.MOX16 7C5 994 04 182 7 6KT.SCHR.MOX20 10E7;15K4 994 04 192 7 6KT.SCHR.MOX60 11G6 994 04 209 7 6KT.SCHR.MOX12 2H6 994 04 212 7 6KT.SCHR.MOX20 2H7;5K8; 11C8 994 04 214 7 6KT.SCHR.MOX25 2H10;8C1; 10J9 994 04 216 7 6KT.SCHR.MOX30 2K4;10J8	993 91 107 8 ZYL.SCHR.MOX18 11C3;11D9; 15D6 993 91 108 7 ZYL.SCHR.MOX25 4E5;8C10; 11E7;15G6 993 91 109 7 ZYL.SCHR.MOX30 2E3;6J11; 993 91 110 7 ZYL.SCHR.MOX35 11F2;11J1 993 91 121 7 ZYL.SCHR.MOX8 8H7 993 91 122 7 ZYL.SCHR.MOX10 7F1;8D8; 15K10 993 91 123 7 ZYL.SCHR.MOX12 2H10;7J11; 7K11;7L3;8D1; 993 92 099 8 GEW.STIFT M5X6 1C8 993 92 183 7 GEW.STIFT M16X70 4L4;4L8 4L9 993 95 092 8 GEW.STIFT M5X6 13G5;13H9 993 95 093 8 GEW.STIFT M5X8 12C1;15J5 993 95 104 8 GEW.STIFT M6X10 10H6 993 96 141 0 FL.KOPFSCHR.M4X12 1F5 993 96 158 7 FL.KOPFSCHR.M5X6 1G5 993 96 160 0 FL.KOPFSCHR.M5X10 1F4 993 96 160 7 FL.KOPFSCHR.M5X10 1F4 993 97 098 7 FL.KOPFSCHR.M4X8 15F8 993 97 098 7 FL.KOPFSCHR.M4X8 9B8;9B10 994 04 109 8 6KT.SCHR.MOX12 1C1 994 04 146 7 6KT.SCHR.MOX8 1F1;9D1 994 04 149 7 6KT.SCHR.MOX12 13H8 994 04 149 8 6KT.SCHR.MOX12 1E1 994 04 150 7 6KT.SCHR.MOX16 2F5 994 04 178 7 6KT.SCHR.MOX10 13E7 994 04 179 7 6KT.SCHR.MOX12 12D3;12E4; 12F5;12H6;12H9;12K10 994 04 180 7 6KT.SCHR.MOX16 8E1;10H10; 15H4 994 04 180 8 6KT.SCHR.MOX16 7C5 994 04 182 7 6KT.SCHR.MOX20 10E7;15K4 994 04 192 7 6KT.SCHR.MOX60 11G6 994 04 209 7 6KT.SCHR.MOX12 2H6 994 04 212 7 6KT.SCHR.MOX20 2H7;5K8; 11C8 994 04 214 7 6KT.SCHR.MOX25 2H10;8C1; 10J9 994 04 216 7 6KT.SCHR.MOX30 2K4;10J8	994 05 035 7 6KT.MUTTER M3,5 2K5 994 05 036 7 6KT.MUTTER M4 1E7;3E12; 3F5;4H2;4H6; 4H7;4H9;4H12; 4K8;6D1;6M8;6E9; 6K12;6M10;7C8; 8A4;12A3;11G12; 15F7;15H10;15L7 4F2;4F10; 6J11;9A8;9D9; 9F8;10D9;10H9; 11E9;11G7;11J7;11K4 2K10;2L9; 2L10;4C9;4F5; 4F8;4C1;4G8;4G9 5J10;6F2;6G2; 6H2;6M9;6K11;8C1; 8H10;9E7;10E7; 12B5;12D9;12J3; 13H10;13K1;15C6; 15G8;15J2;15J6; 15K1 4H2;4H12; 4J6;6L1;7C4;7F3; 7F12;7G3;7H4;7H8; 8B2;10H8;15L5 5K5;5L4; 7H2 4G5;4L4; 4L8;4L12;5G1 4J4;4J7; 4J8;4K4;4L7;4M6 2J9 7E4; 7G8;7J8; 10L11 1H10 8A3;12F10	994 38 109 8 SPANNHUELSE 5X20 7H4 994 38 121 8 SPANNHUELSE 5X60 1H7 994 38 436 0 SPANNSTIFT 4X10 13F8 994 38 442 0 SPANNSTIFT 4X25 12C1;15J4 994 46 070 8 ZYL.SCHR.MOX10 2J5 994 46 101 7 ZYL.SCHR.MOX12 1E11 994 46 102 8 ZYL.SCHR.MOX16 2G7 994 46 110 7 ZYL.SCHR.MOX10 1K9 994 46 124 7 ZYL.SCHR.MOX25 8B1 994 46 534 7 ZYL.SCHR.MOX12 2F9 994 80 144 7 SCHEIBE 4,3 1F6;6M8;13H5; 13K9 994 80 145 7 SCHEIBE 5,3 8E1;11F11 994 80 146 7 SCHEIBE 6,4 2K5;2L5;4C9; 7L3;7J11;7K11; 13H5;13K1;15L1; 15M2 994 80 148 7 SCHEIBE 8,4 3G9 994 80 149 7 SCHEIBE 10,5 2J8;3G8 4A8;4E5;4G3; 4G10;7D8 995 18 038 7 6KT.MUTTER LI M6 12A5;12B6 12E10;12J4 995 19 013 8 SPANNHUELSE 2X8 1J4 995 19 153 8 SPANNHUELSE 5X8 2E9 995 34 061 8 6KT.MUTTER PG11 9F8;9F9 995 42 073 8 SENKSCHR.M8 5G3 995 43 029 0 RGKPF.ZYL.STI 13G2 996 01 086 8 SICHR.RING 10X1 15G3 996 01 088 8 SICHR.RING 12X1 8E7 996 01 091 8 SICHR.RING 15X1 106;7D4;7E4; 7C7;7C8;7G8 996 01 303 8 SICHR.RING 18X1,5 9F9 996 02 127 8 SICHR.RING 47X1,75 1D6;1E9 996 06 017 0 KUGEL 3,969 1E5; 996 07 006 8 SICHR.SCHEIBE 3,2 1C6;1D7; 1E1 996 07 007 8 SICHR.SCHEIBE 4 8C8;8D9;				

