



M-TYPE PREMIUM

Additional Instructions

Electronic edge guide

IMPORTANT
READ CAREFULLY BEFORE USE
KEEP FOR FUTURE REFERENCE

All rights reserved.

Property of Dürkopp Adler GmbH and protected by copyright. Any reuse of these contents, including extracts, is prohibited without the prior written approval of Dürkopp Adler GmbH.

Copyright © Dürkopp Adler GmbH 2021

1	General information	3
1.1	Components of the kit 0867 593714 (one-axis electronic edge guide)	3
1.2	Components of the kit 0867 593704 (two-axis electronic edge guide).....	3
2	Assembly.....	4
2.1	One-axis electronic edge guide	5
2.1.1	Assembling the edge guide	5
2.1.2	Setting the height of the edge guide.....	9
2.2	Assembling the two-axis electronic edge guide.....	10
3	Software settings.....	15
3.1	Software settings on the OP3000 control panel	15
3.1.1	Activating the electronic edge guide	15
3.1.2	Calibrating the electronic edge guide	16
3.2	Software setting on the Commander control panel.....	17
3.2.1	Activating the electronic edge guide.....	17
3.2.2	Calibrating the electronic edge guide	18
4	Checking the circuit board setting.....	19

1 General information

1.1 Components of the kit 0867 593714 (one-axis electronic edge guide)

Check whether the scope of delivery for kit 0867 593714 is correct prior to installation.

Part number	Quantity	Designation
	1	electronic edge guide (pre-assembled)
9870 867006	1	CAN cable
9870 867067	1	CAN cable
0867 593760	1	Cover
9204 201697	1	Pan-head screw M4x16-H
9204 201717	3	Pan-head screw M4x20-H
9202 002387	2	Cylinder-head bolt M4x22
9205 122488	1	Threaded pin M6x10
9210 023417	1	Knurled screw M5x20
0467 220660	1	Compression spring

1.2 Components of the kit 0867 593704 (two-axis electronic edge guide)

Check whether the scope of delivery for kit 0867 593704 is correct prior to installation.

Part number	Quantity	Designation
	1	electronic edge guide (pre-assembled)
9202 150757	3	Countersunk screw M6x16
0867 593780	3	Sleeve
9870 867066	1	CAN cable
9870 867067	1	CAN cable
0867 593740	1	Cover
0867 593750	1	Cover
9204 431657	8	Cylinder-head bolt M4x10

2 Assembly

NOTICE

Property damage may occur!

Risk of breakage from using edge guides not made by Dürkopp Adler.

The kits are intended for edge guides with an axle suspension height of 15 mm and a width of 24 mm.

If using edge guides with different dimensions, you **MUST** recalibrate the edge guide ( p. 15).

Travel paths of the edge guides

The lateral travel path is 1.0 - 45 mm.

The vertical travel path is 0.1 - 12 mm.



Important

If using edge guides not made by Dürkopp Adler, you need to ensure that their width and their height do not deviate from Dürkopp Adler's edge guides by more than + 10 mm and + 8 mm, respectively.

If **the length and height dimensions are greater** than the Dürkopp Adler edge guide, the maximum travel path will be reduced.

If **the length and height dimensions are smaller** than the Dürkopp Adler edge guide, the minimum distances (X-axis: 1 mm; Z-axis: 0.1 mm) can no longer be achieved.

2.1 One-axis electronic edge guide

2.1.1 Assembling the edge guide

Fig. 1: Assembling the edge guide (1)

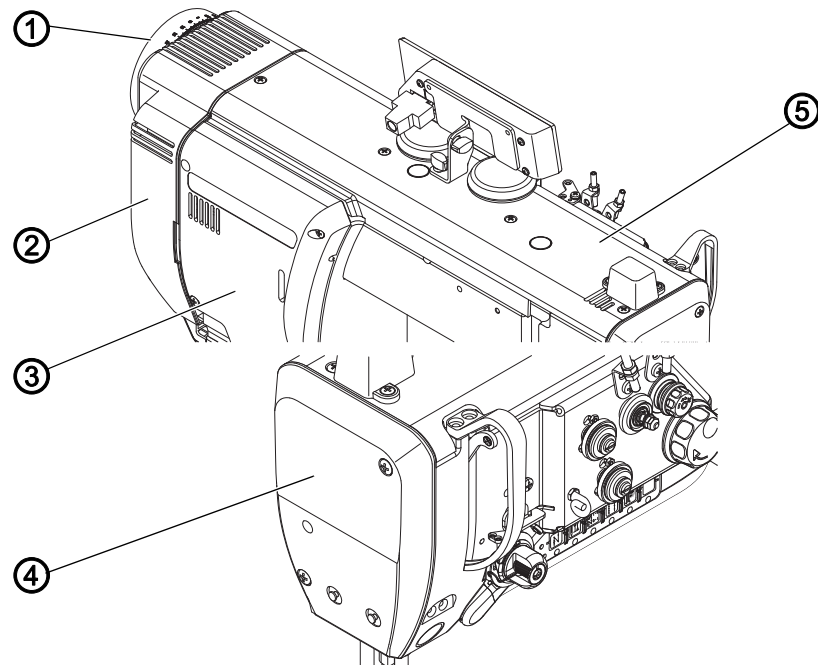

(1) - Handwheel
 (2) - Motor cover
 (3) - Valve cover

(4) - Head cover
 (5) - Arm cover



To assemble the electronic edge guide:

1. Switch off the machine.
2. Remove the control panel.
3. Remove head cover (4), arm cover (5) and valve cover (3).
4. Remove the handwheel (1) and the motor cover (2).



Information

Handwheel and motor cover ONLY need to be removed for -M PREMIUM machines. On other machines, the distributor board on the machine head is installed below the valve cover.

Fig. 2: Assembling the edge guide (2)

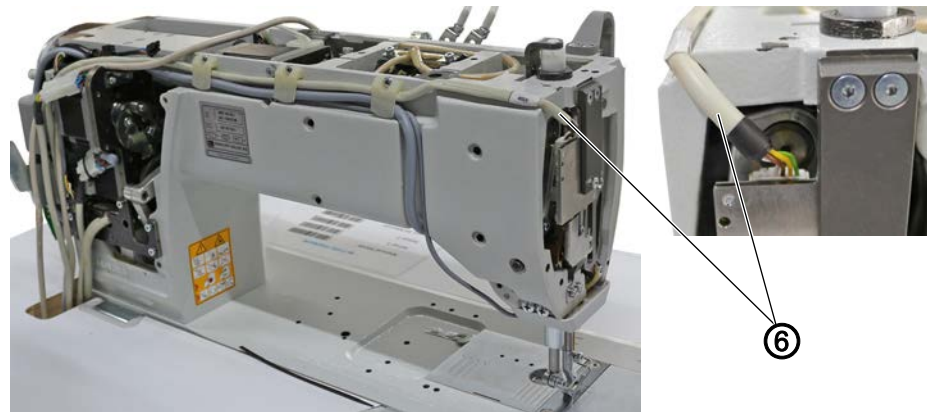

(6) - Material thickness detection cable



5. Loosen the material thickness detection cable (6) from the circuit board on the machine head.
6. Pull the material thickness detection cable (6) from the CAN socket on the control.
7. Remove the material thickness detection cable (6) from the machine. This cable is no longer needed.

Fig. 3: Assembling the edge guide (3)

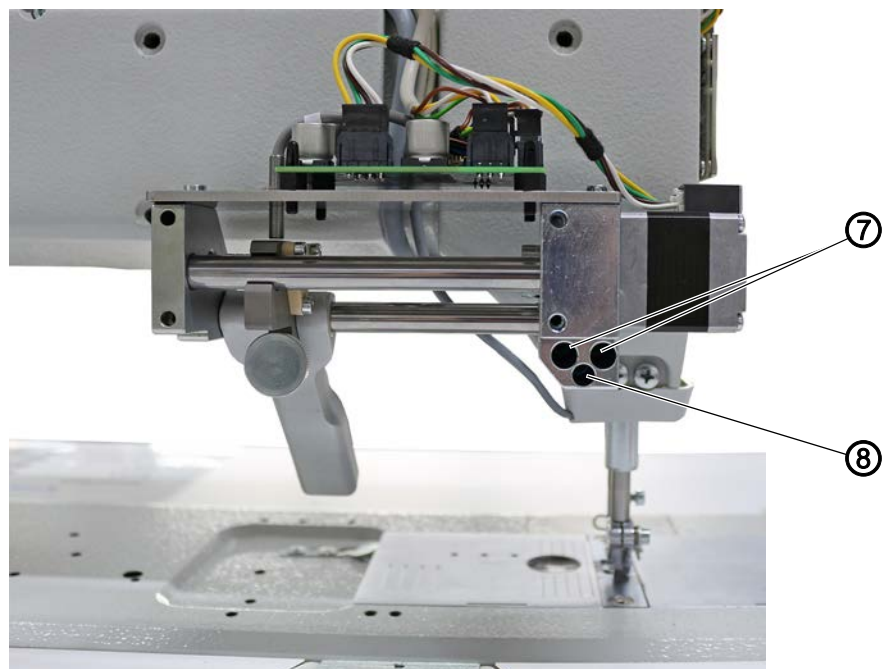

(7) - Screws

(8) - Threaded pin



8. Use the screws (7) and the threaded pin (8) to tighten the edge guide.

Fig. 4: Assembling the edge guide (4)

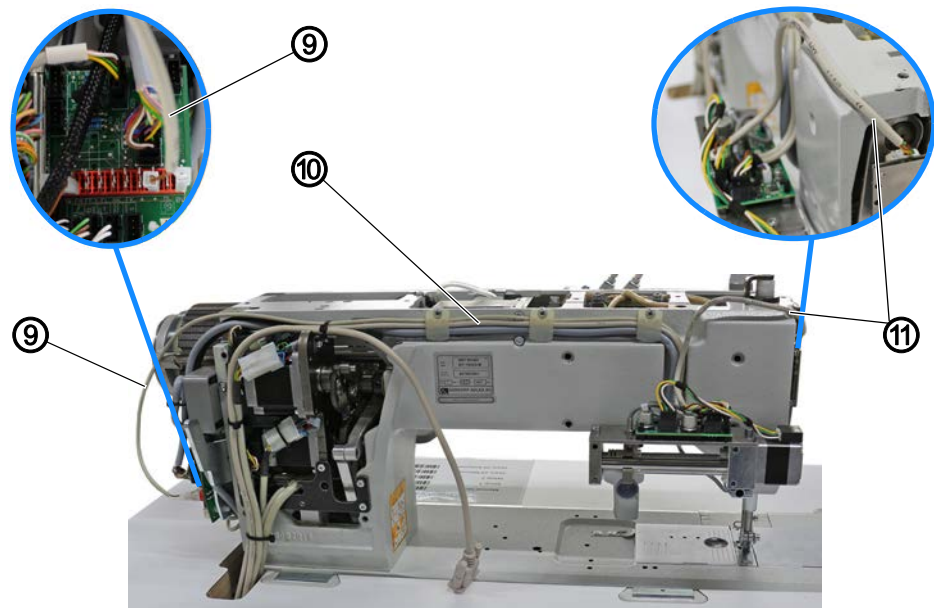

(9) - Cable to the power supply
(10) - CAN cable

(11) - Material thickness detection cable



9. Lay the cable to the power supply (9) (slot at the edge guide circuit board: **X105**) on the machine arm.

10. Insert the cable to the power supply (9) at the circuit board on the sewing motor.

- brown cable (+ terminal): 3rd slot from the right
- white cable (- terminal): 1st slot from the right

11. Lay the CAN cable (10) (slot at the edge guide circuit board: **X105**) on the machine arm and feed it downwards through the tabletop cutout.

12. Connect the CAN cable (10) to the CAN socket on the control.

13. Lay the material thickness detection cable (11) (slot at the edge guide circuit board: **X103**) to the machine head.

14. Insert the material thickness detection cable (11) at the circuit board on the machine head.



Important

When laying the cables, make sure the cables do NOT hinder the movements of the moving parts in the machine.

Fig. 5: Assembling the edge guide (5)



15. Place all covers again and tighten them.
While doing so, make sure not to pinch any cables.



Information

The cover of the edge guide is tightened using 3 long screws and one short screw.
The short screw needs to be screwed into the upper left hole of the cover.



16. Connect the control panel.

2.1.2 Setting the height of the edge guide

You can use the knurled screw included in the kit to adjust the height of the edge guide by up to 8 mm.

Fig. 6: Setting the height of the edge guide

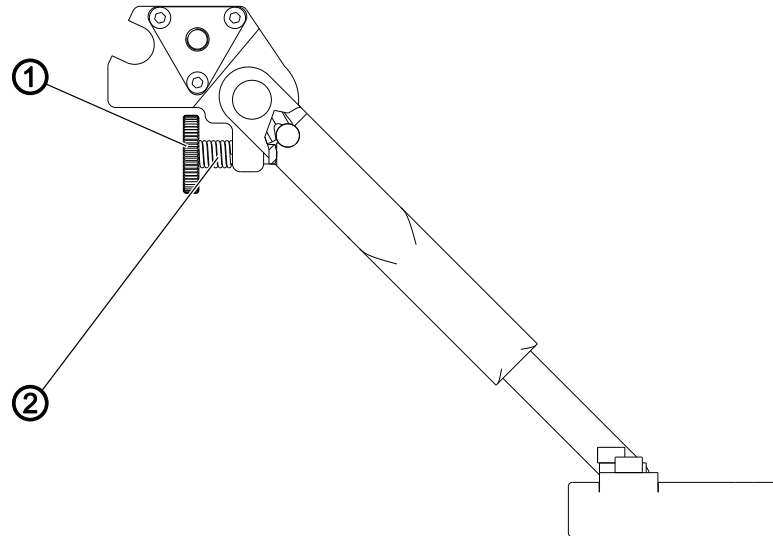

(1) - Knurled screw

(2) - Compression spring



To set the height of the electromotive edge guide:

1. Replace the cylinder-head bolt and the nut on the rear of the edge guide with the knurled screw (1) with compression spring (2).
2. Turn the knurled screw (1) until you have reached the desired height of the edge guide.
 - **To set the edge guide higher:** Turn the knurled screw (1) clockwise
 - **To set the edge guide lower:** Turn the knurled screw (1) counter-clockwise

2.2 Assembling the two-axis electronic edge guide

Fig. 7: Assembling the two-axis electronic edge guide (1)

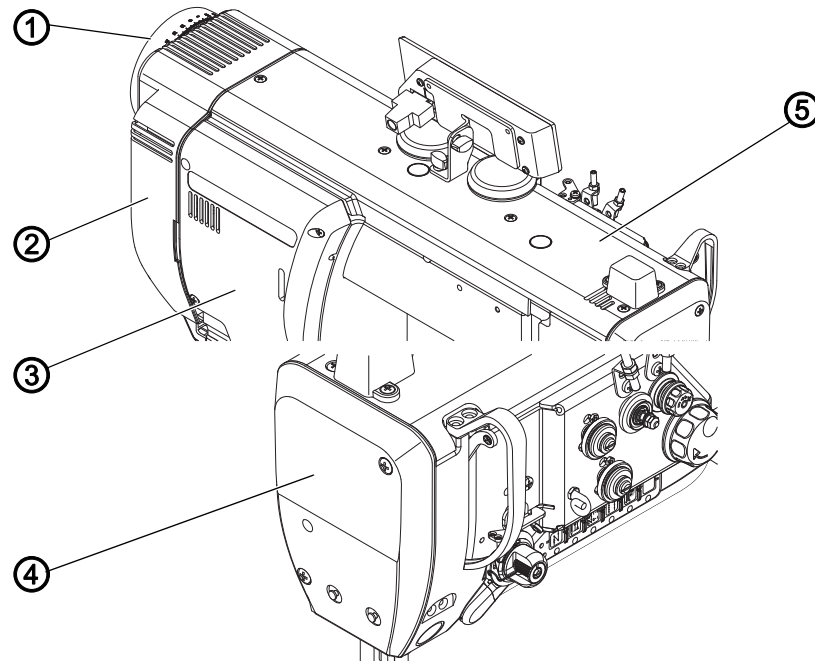

(1) - Handwheel
(2) - Motor cover
(3) - Valve cover

(4) - Head cover
(5) - Arm cover



To assemble the electronic edge guide:

1. Switch off the machine.
2. Remove the control panel.
3. Remove head cover (4), arm cover (5) and valve cover (3).
4. Remove the handwheel (1) and the motor cover (2).



Information

Handwheel and motor cover **ONLY** need to be removed for -M PREMIUM machines. On other machines, the distributor board on the machine head is installed below the valve cover.

Fig. 8: Assembling the two-axis electronic edge guide (2)

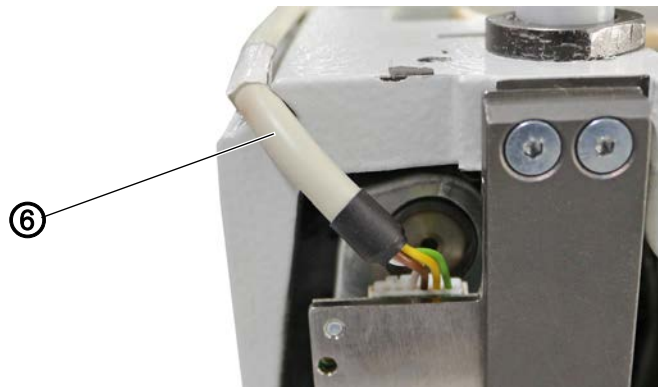

(6) - Material thickness detection cable



5. Loosen the material thickness detection cable (6) from the circuit board on the machine head.
6. Pull the material thickness detection cable (6) from the CAN socket on the control.
7. Remove the material thickness detection cable (6) from the machine. This cable is no longer needed.

Fig. 9: Assembling the two-axis electronic edge guide (3)

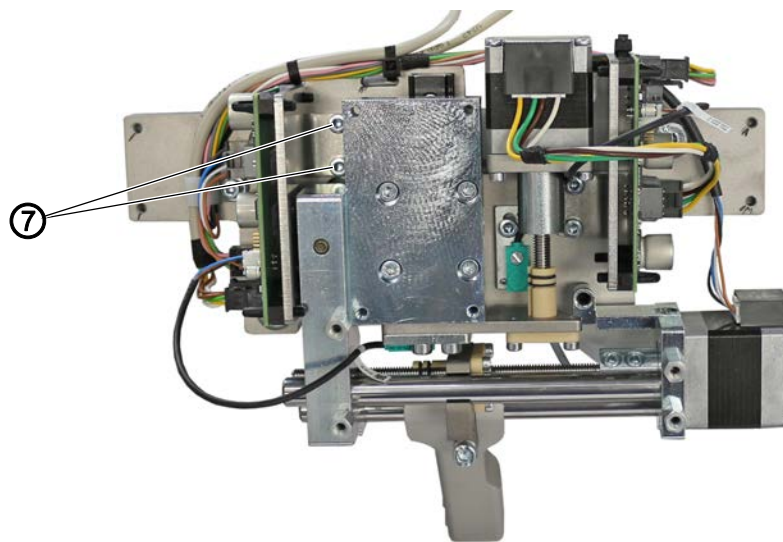

(7) - Screws



8. Loosen the screws (7) on the circuit board holder.

Fig. 10: Assembling the two-axis electronic edge guide (4)

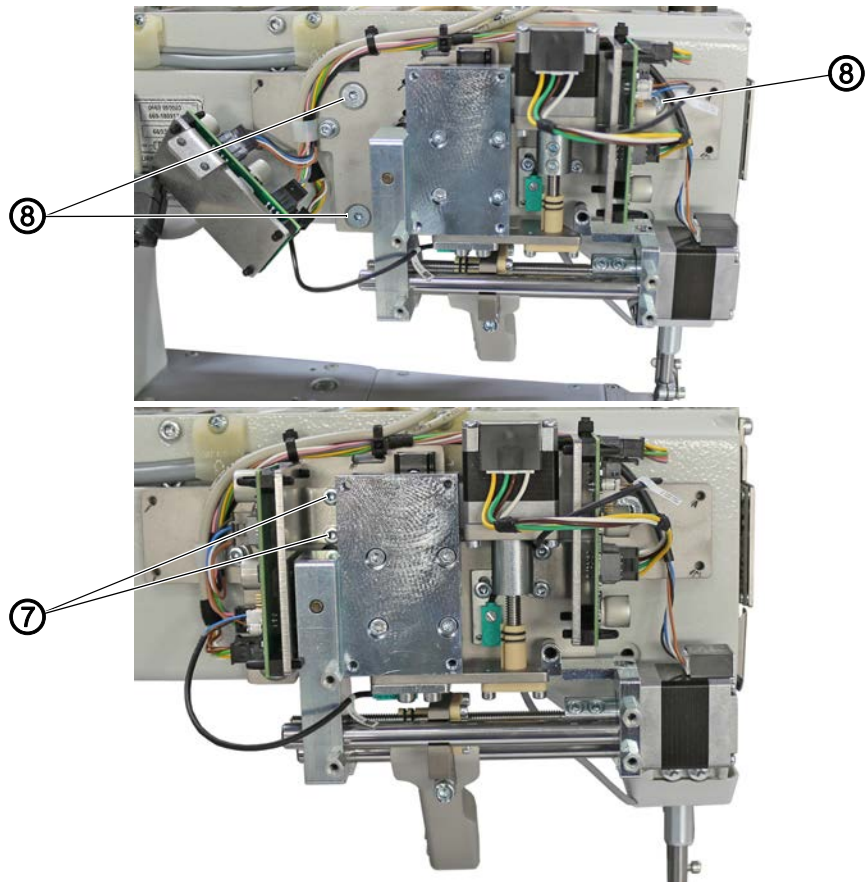

(7) - Screws

(8) - Screws



9. Tighten the edge guide using the screws (8).
Make sure to fit the sleeves as spacers between machine housing and edge guide holder.
10. Tighten the circuit board holder using the screws (7).

Fig. 11: Assembling the two-axis electronic edge guide (5)

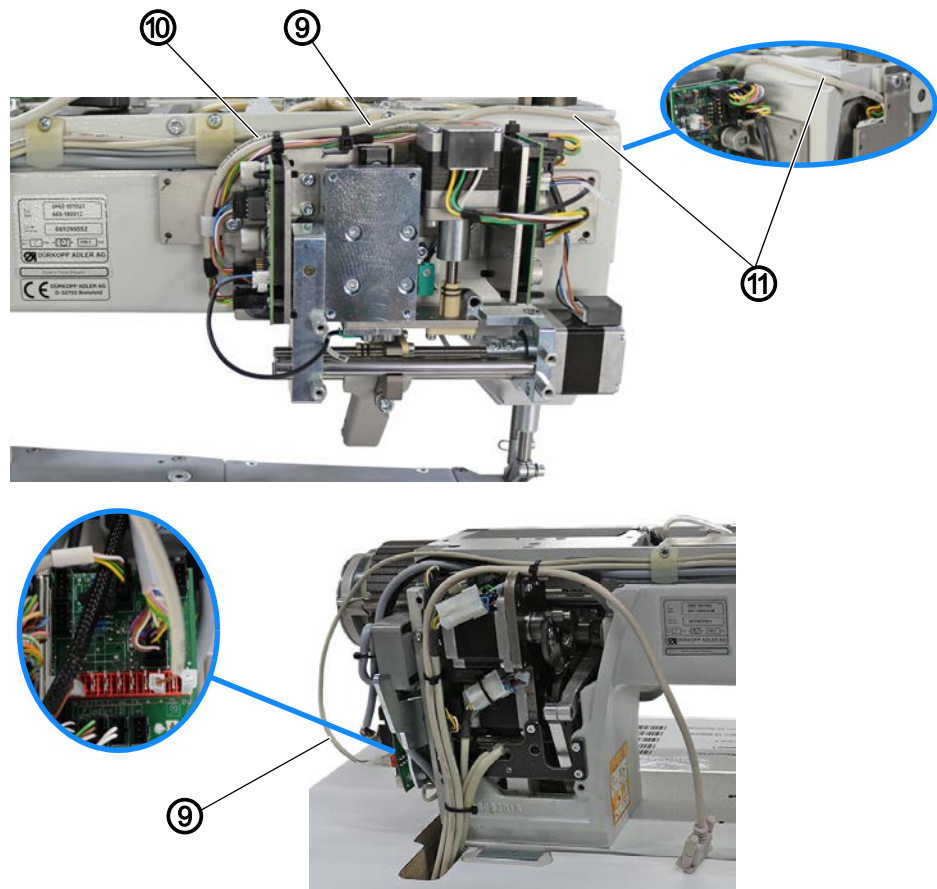

(9) - Cable to the power supply
(10) - CAN cable

(11) - Material thickness detection cable



11. Lay the cable to the power supply (9) (slot at the edge guide circuit board: **X103**) on the machine arm.
12. Insert the cable to the power supply (9) at the circuit board on the sewing motor.
 - brown cable (+ terminal): 3rd slot from the right
 - white cable (- terminal): 1st slot from the right
13. Lay the CAN cable (10) (slot at the edge guide circuit board: **X103**) on the machine arm and feed it downwards through the tabletop cutout.
14. Connect the CAN cable (10) to the CAN socket on the control.
15. Lay the material thickness detection cable (11) from the edge guide circuit board (slot at the edge guide circuit board: **X105**) to the machine head.
16. Insert the material thickness detection cable (11) at the circuit board on the machine head.



Important

When laying the cables, make sure the cables do NOT hinder the movements of the moving parts in the machine.

Fig. 12: Assembling the two-axis electronic edge guide (6)



17. Place all covers again and tighten them.
While doing so, make sure not to pinch any cables.



Information

The cover of the edge guide is composed of 2 sections.
Start by screwing on the bottom section. The upper section of the cover overlaps the bottom section.



18. Connect the control panel.

3 Software settings

NOTICE

Property damage may occur!

Risk of breakage if the electronic edge guide settings are incorrect.

Follow the minimum distance between electronic edge guide and sewing equipment.

NOTICE

Property damage may occur!

Risk of breakage from using edge guides not made by Dürkopp Adler.

If using edge guides not made by Dürkopp Adler, you **MUST** recalibrate the edge guide.

3.1 Software settings on the OP3000 control panel



3.1.1 Activating the electronic edge guide



To activate the electronic edge guide:

1. Switch on the machine.
2. Press the **P** and **S** buttons on the control panel at the same time.
 - ↳ The input screen for the password appears.
3. Use the numeric buttons to enter the password (25483).
 - ↳ You are on the Technician level:
4. Open the menu *Machine configuration* and select the *Edge guide* submenu.

The *Edge guide* menu allows you to set the following parameters:

Menu items	Value range
<i>Edge guide</i>	Value range On/Off
<i>Edge guide mode</i>	Value range <ul style="list-style-type: none"> • 1-axis Internal/ • 1-axis External/ for 1-axis edge guide  p. 5 • 2-axis External for 2-axis edge guide  p. 10
<i>Motor</i>	Value range On/Off
<i>Min. gap</i> CAUTION: the minimum distance varies with the sewing equipment used	



5. Calibrate the electronic edge guide after activating it.

3.1.2 Calibrating the electronic edge guide



To calibrate the electronic edge guide:

Lateral distance of the edge guide

1. Flip up the edge guide.
2. Call up the *Service > Calibration > Edge Guide* menu item.
3. Confirm the selection with **OK**.
- ↳ The edge guide moves to the reference position.
4. Fold the edge guide down.
5. Measure the distance between the needle and the edge guide.
6. Enter the value with the ▲/▼ buttons.
7. Confirm the entry with **OK**.
- ↳ The calibration is complete.

Height of the edge guide (only for 2-axis edge guide)



1. Call up the *Service > Calibration > Edge Guide Height* menu item.
- ↳ The control panel displays the value **5 mm**.
2. Place the locking pin included in the accessory pack under the edge guide.
3. Use the ▲/▼ buttons to move the edge guide until the edge guide slightly clamps the locking pin.
The value on the display will NOT change.
4. Confirm the entry with **OK**.
- ↳ The calibration is complete.

3.2 Software setting on the Commander control panel





3.2.1 Activating the electronic edge guide



To activate the electronic edge guide:

1. Switch on the machine.
2. Log in as the Default Technician on the control panel.
3. Press the symbol  to bring up the navigation pane.
 - ↳ This opens the navigation interface.
4. Open the menu *Settings* > *Machine configuration* and tap the  **Edge guide** symbol.

The *Edge guide* menu allows you to set the following parameters:

Icon	Menu items	Value range
	<i>Edge guide</i>	Value range On/Off
	<i>Edge guide mode</i>	Value range <ul style="list-style-type: none"> • 1-axis Internal/ • 1-axis External/ for 1-axis edge guide  p. 5 • 2-axis External for 2-axis edge guide  p. 10
	<i>Electromotive</i>	Value range On/Off
	<i>Speed</i> Travel speed of the edge guide	Value range 0500 - 60000 [Hz]
	<i>Min. gap</i> CAUTION: the minimum distance varies with the sewing equipment used	



5. Calibrate the electronic edge guide after activating it.



Information

After setting the parameters, you must restart the machine. After restarting, the machine will display a software update prompt. Confirm with **OK**.

3.2.2 Calibrating the electronic edge guide



To calibrate the electronic edge guide:

Lateral distance of the edge guide

1. Flip up the edge guide.
2. Call up the *Service > Calibration > Edge Guide* menu item.
3. Confirm the selection with **OK**.
- ↳ The edge guide moves to the reference position.
4. Fold the edge guide down.
5. Measure the distance between the needle and the edge guide.
6. Enter the value with the **-/+** buttons.
7. Confirm your entry with **Next**.
- ↳ The calibration is complete.

Height of the edge guide (only for 2-axis edge guide)

1. Call up the *Service > Calibration > Edge Guide Height* menu item.
- ↳ The control panel displays the value **5 mm**.
2. Place the locking pin included in the accessory pack under the edge guide.
3. Use the **-/+** buttons to move the edge guide until the edge guide slightly clamps the locking pin.
The value on the display will NOT change.
4. Confirm your entry with **Next**.
- ↳ The calibration is complete.

4 Checking the circuit board setting

If replacing one or both circuit boards on the electronic edge guide, check the position of the DIP switches.

DIP switch for the lateral travel movement of the edge guide

Fig. 13: DIP switch for the lateral travel movement of the edge guide

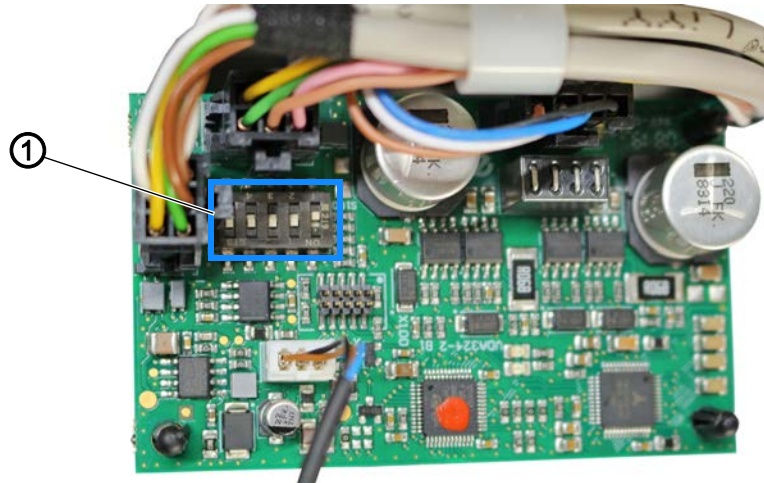

(1) - DIP switch



Proper setting

Position 1 is set to **OFF**.
Positions 2-5 are set to **ON**.

DIP switch for the up and down movement of the edge guide (ONLY for 2-axis edge guide)

Fig. 14: DIP switch for the up and down movement of the edge guide

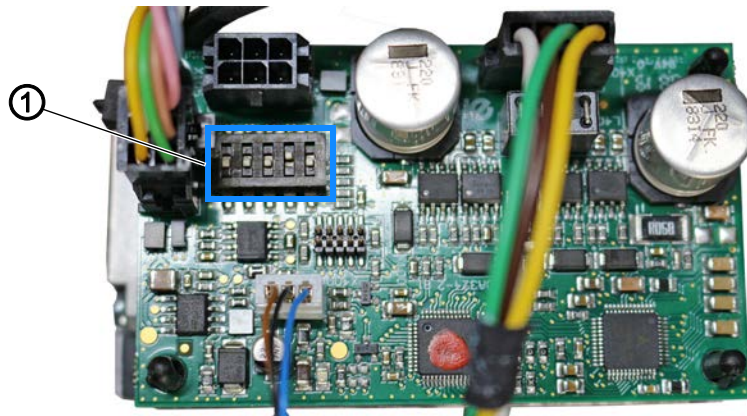

(1) - DIP switch



Proper setting

Position 1 is set to **ON**.
Position 2 is set to **OFF**.
Positions 3-5 are set to **ON**.



DÜRKOPP ADLER GmbH
Potsdamer Str. 190
33719 Bielefeld
Germany
Phone: +49 (0) 521 925 00
Email: service@duerkopp-adler.com
www.duerkopp-adler.com